

# SIEMENS

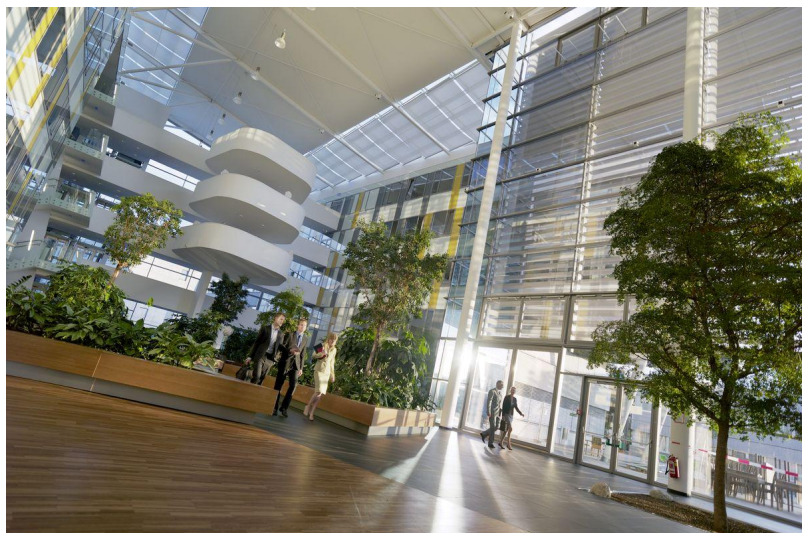

## Desigo Configurable Room Automation (BACnet)

### Product Range Description

### Application Guide

# Table of Contents

<b>1</b>	<b>Product range overview .....</b>	<b>7</b>
<b>2</b>	<b>Connecting to the automation level.....</b>	<b>13</b>
<b>3</b>	<b>Connecting to Desigo CC.....</b>	<b>14</b>
<b>4</b>	<b>Applications.....</b>	<b>15</b>
<b>5</b>	<b>User roles .....</b>	<b>17</b>
<b>6</b>	<b>Web server.....</b>	<b>18</b>
<b>7</b>	<b>Rooms and room segments.....</b>	<b>19</b>
<b>8</b>	<b>Central function with groups .....</b>	<b>22</b>
<b>9</b>	<b>Alarms .....</b>	<b>24</b>
9.1	System alarms on DXR2.....	24
9.2	Preconfigured system alarms.....	24
9.3	Process alarms on free inputs.....	24
9.4	Time response to system and process alarms.....	25
<b>10</b>	<b>Trends.....</b>	<b>26</b>
<b>11</b>	<b>Control function .....</b>	<b>27</b>
11.1	Room operating modes.....	27
11.2	Room operating mode determination .....	27
11.3	Plant operating mode determination.....	29
11.4	Room controller and setpoints.....	31
11.4.1	Temperature setpoints .....	31
11.4.2	Temperature control: Direct or cascading.....	33
11.4.3	Air quality setpoints.....	34
11.4.4	Setpoints for air volume tracking .....	34
11.4.5	Setpoints for relative humidity .....	34
11.4.6	Room controller output signals .....	35
11.4.7	Activate aggregates based on plant operating mode .....	37
11.4.8	Controller operating mode for heating and cooling aggregates based on the plant operating mode .....	38
11.4.9	Stage controller of aggregates .....	39
11.5	Output signals to the aggregates .....	40
11.5.1	Staged output .....	41
11.5.2	Modulating output .....	41
<b>12</b>	<b>Operation in room .....</b>	<b>42</b>
12.1	Green Leaf .....	43
12.2	Room operator unit QMX3.P34 .....	44
12.3	Room operator unit QMX3.P74 .....	45
12.4	Room operator unit QMX3.P36.....	47
12.4.1	Layouts for fan coil applications .....	47
12.4.2	Layouts for radiators and ceiling heating/chilled ceiling applications.....	48
12.4.3	Layouts for VAV applications .....	49

12.5	Room operator unit QMX3.P37 .....	50
12.5.1	HVAC operator panel (upper half) .....	50
12.5.2	Electric operator panel (lower half) .....	51
12.6	Room operator unit QMX3.P02 .....	52
12.6.1	Electric operator panel (lower half) .....	52
<b>13</b>	<b>Room coordination functions.....</b>	<b>54</b>
13.1	Room functions: Room coordination.....	55
<b>14</b>	<b>Radiator application .....</b>	<b>61</b>
14.1	Hot water radiator application.....	61
14.2	Electric radiator application .....	63
14.3	Determination of heating/cooling state .....	65
14.4	Heating/cooling demand .....	65
14.5	Preheating .....	65
14.6	Emergency operation.....	65
14.7	Reset setpoint.....	65
14.8	Free inputs/outputs .....	66
14.9	Centrally override valves.....	66
14.10	Presence control.....	66
14.11	Application examples .....	67
14.11.1	Radiator .....	67
<b>15</b>	<b>Radiant/chilled ceiling application .....</b>	<b>68</b>
15.1	2-pipe chilled ceiling .....	68
15.2	2-pipe heated/chilled ceiling with changeover system.....	69
15.3	4-pipe ceiling heating/chilled ceiling with changeover valves .....	70
15.4	4-pipe heated/chilled ceiling with 6-port valve.....	71
15.5	2-pipe ceiling heating .....	72
15.6	Actuators.....	73
15.7	Valve protection.....	73
15.8	Determination of heating/cooling state .....	73
15.9	Heating/cooling demand .....	73
15.10	Preheating .....	74
15.11	Emergency operation.....	74
15.12	Free cooling.....	74
15.13	Reset setpoint.....	74
15.14	Free inputs/outputs .....	75
15.15	Centrally override valves.....	75
15.16	Presence control.....	75
15.17	Application examples .....	76
15.17.1	Chilled/heated ceiling .....	76
<b>16</b>	<b>Fan coil application .....</b>	<b>77</b>
16.1	Serial or parallel control strategy .....	77
16.2	Air volume flow in the dead zone.....	79
16.3	Control of staged fan .....	79
16.4	Control of modulating fan.....	81
16.5	Water register for 4-pipe system .....	82
16.6	Water register 2-pipe system with changeover .....	83

16.7	Water register for 4-pipe system with changeover valves .....	84
16.8	Water register 4-pipe system with 6-port valve .....	85
16.9	Water register 2-pipe system, cooling only .....	87
16.10	Water register 2-pipe system, heating only.....	88
16.11	Actuators.....	88
16.12	Valve protection.....	89
16.13	Determination of heating/cooling state .....	89
16.14	Heating/cooling demand .....	89
16.15	Preheating.....	90
16.16	Emergency operation.....	90
16.17	Night cooling.....	90
16.18	Free cooling.....	90
16.19	Reset setpoint .....	90
16.20	Free inputs/outputs.....	91
16.21	Centrally override valves.....	91
16.22	Electric heating coil.....	91
16.23	Electric reheater .....	93
16.24	Room supply air cascade.....	95
16.25	Air quality control.....	96
16.26	Dehumidification control.....	96
16.27	Outside air damper control.....	97
16.28	Presence control.....	98
16.29	Application examples .....	99
16.29.1	Fan coil unit .....	99
<b>17</b>	<b>VAV application .....</b>	<b>100</b>
17.1	Serial or parallel control strategy.....	100
17.2	Air volume flow in the dead zone .....	102
17.3	Volume flow setpoints heating/cooling.....	104
17.4	Air volume control.....	104
17.4.1	External volume air flow control.....	105
17.4.2	Internal volume flow control.....	105
17.5	Parallel supply air VAV or extract air VAV .....	106
17.6	Outputs .....	106
17.7	Switch-off delay .....	106
17.8	Return air sensor .....	106
17.9	Locked by electric heating coils.....	107
17.10	Start of air volume flow by heating demand.....	107
17.11	Water register for 4-pipe system .....	107
17.12	Water register 2-pipe system with changeover .....	108
17.13	Water register for 4-pipe system with changeover valves .....	109
17.14	Water register 4-pipe system with 6-port valve.....	110
17.15	Water register 2-pipe system, cooling only .....	112
17.16	Water register 2-pipe system, heating only.....	113
17.17	Actuators.....	113
17.18	Valve protection.....	114
17.19	Determination of heating/cooling state .....	114

17.20 Heating/cooling demand .....	114
17.21 Preheating .....	115
17.22 Emergency operation.....	115
17.23 Reset setpoint.....	115
17.24 Free inputs/outputs .....	115
17.25 Centrally override valves.....	115
17.26 Electric heating coil.....	116
17.27 Electric reheater .....	118
17.28 Night cooling.....	120
17.29 Presence control.....	120
17.30 Static calibration .....	121
17.31 Dynamic calibration .....	121
17.32 Application examples .....	122
17.32.1 Variable air volume .....	122
<b>18 Fan-Powered Box.....</b>	<b>123</b>
18.1 Serial or parallel control strategy for the fan .....	130
18.2 Air volume flow in the dead zone.....	132
18.3 Air volume control.....	132
18.3.1 External volume air flow control.....	133
18.3.2 Internal volume flow control.....	133
18.4 Outputs.....	133
18.5 Switch-off delay .....	133
18.6 Return air sensor .....	134
18.7 Locked by electric heating coils.....	134
18.8 Start of air volume flow by heating demand.....	134
18.9 Actuators .....	134
18.10 Valve protection.....	135
18.11 Determination of heating/cooling state .....	135
18.12 Heating/cooling demand .....	135
18.13 Preheating .....	136
18.14 Emergency operation.....	136
18.15 Reset setpoint.....	136
18.16 Free inputs/outputs .....	136
18.17 Centrally override valves.....	136
18.18 Electric reheater .....	136
18.19 Night cooling.....	137
18.20 Presence control.....	137
18.21 Application examples .....	138
18.21.1 Fan powered box .....	138
<b>19 Lighting applications .....</b>	<b>139</b>
19.1 Manual switching or dimmed light .....	139
19.2 Stairwell lighting.....	141
19.3 Presence-dependent lighting control .....	143
19.4 Control for daylight based lighting and dusk/dawn switching.....	147
19.5 Constant lighting control with one light group in the room .....	149

19.6	Constant lighting control with multiple lighting groups in the room .....	152
19.7	Operating strategy for light.....	155
<b>20</b>	<b>Blinds applications .....</b>	<b>159</b>
20.1	Local blinds operations .....	159
20.2	Operating strategy for blinds .....	161
<b>21</b>	<b>Central applications.....</b>	<b>163</b>
21.1	Automation station for HVAC supply and demand signals and manual control for lighting and blinds .....	164
21.1.1	Control room operating mode via onboard I/Os .....	165
21.1.2	Manual control of lighting & blinds via KNX PL-Link.....	166
21.1.3	HVAC supply chain chilled water over BACnet .....	167
21.1.4	HVAC supply chain hot water over BACnet.....	169
21.1.5	HVAC supply chain air over BACnet .....	171
21.1.6	Room operating mode over BACnet.....	174
21.2	Automation station for emergency controls for HVAC, light, and blinds.....	175
21.3	Automation station for weather station .....	180
21.4	Automation station for facade control .....	185
21.5	Application examples .....	186
21.5.1	Central function.....	186
<b>22</b>	<b>Technical principles, terms.....</b>	<b>187</b>

# 1 Product range overview

## Room automation station DXR2

The DXR2 room automation stations are perfectly suited for creating the ideal comfort conditions for the room user. They measure room air temperature, air quality (CO<sub>2</sub>), and humidity, and control fan coils, air volume flow, chilled and heated ceilings, radiators, and floor heating.

Moreover, the DXR2.. can be supplemented with lighting and shading functions by adding the KNX PL-Link module.



Figure: DXR 2 room automation stations

## Applications

The DXR2 automation station can be flexibly configured, regardless of available inputs and outputs. The following tested and flexible applications are available, needing only to be configured. The following applications are available:

- Air temperature control/variable air volume control (VAV)
- Fan coil units
- Chilled/heated ceilings
- Radiator/floor heating

All configurable DXR2s can also be combined with lighting and blinds applications.

Configurable applications meet the functional scope per VDI 3813 and permit achievement of energy class A per EN 15232.

## Central functions

Information is centrally collected and evaluated to operate the entire system in an energy optimized way. Each application is already set up to have all the relevant information that can then be read without additional programming.

Energy relevant information includes:

- Ventilation system: Heating/cooling demand (optimum supply air temperature), air demand (optimum supply air pressure or air volume)
- Hot water/chilled water (2 pipe): Heat demand, cooling demand, heating/cooling (changeover), etc.
- Chilled water system: Cooling demand, etc.
- Hot water system: Hot demand

Engineering central control or central measured values is child's play: Simply enable prepared functions already available in the applications (no additional programming required).

The functions include:

- Central operation of operating mode
- Distribution of measured values from the weather station
- Central blinds control

**Functional extension  
KNX PL-Link**

Each DXR2 has an integrated KNX PL-Link interface. The interface integrated communicating room operator units and field devices. One device on the KNX PL-Link is as easy to engineer and functionally integrate as the fixed inputs and outputs on the DXR automation station. In the event a device fails on the PL-Link and requires replacement, the new device operates immediately after mounting--no additional effort required.

**Flexible room occupancy**

How space is allocated is often flexible in a lot of buildings, rooms are occupied as large open offices or individual ones. Walls are only added after consulting with lessor, and are often rearrange during the occupancy phase.

The applications in the DXR2 are designed to adapted to current occupancy in a flexibly manner. For example, control and operation automatically applies to the entire room if two room segments are combined into one, as the responsible DXR2 automatically coordinates the changes over communications.

**Open system**

All BACnet and KNX are fixed integrated on DR2 room automation stations and thus support the two most important standards in building automation and control. They can be integrated into a superposed system without additional with further ado. And future changes and extensions are no problem thanks to the open standards.

Even IT standards are supported, for example, to directly access the web server integrated on the DXR2 using any standard web browser. Of course, a password is required to operate data points and prevent authorized access.

**Wall mounted room  
operator KNX PL-Link**

All DXR2s support the QMX3 room operator units and room sensors for wall mounting. The devices, featuring KNX PL-Link communications, can acquire, depending on the type, the room temperature, humidity, and air quality. Types are available with or without display and operating elements, Green Leaf or air quality indicators.

So that you can compile customized operating concepts ranging from merely acquiring measured values with indication (sensors), to comprehensive display and operation of room conditions (HVAC), or combining the same with lighting and shading to create a custom operating concept.





**Figure: Room operator units and room sensors for wall mounting**

**Flush mounted room operator units  
KNX PL-Link**

All DXR2s support the QMX3 room operator units and AQR room sensors for flush mounting. The devices, featuring KNX PL-Link communications, can acquire, depending on the type, room temperature, humidity, and air quality (CO<sub>2</sub>). Types are available with or without display and operating elements, Green Leaf or air quality indicators.



All commonly used internal flush mounting formats are supported, so that these devices can be combined with virtually any switching program. So that you can compile customized operating concepts ranging from merely acquiring measured values with indication (sensors), to comprehensive display and operation of room conditions (HVAC), or combining the same with lighting and shading to create a custom operating concept.



**Figure: Room operator units and room sensors for flush mounting**

## Green Leaf

The leaf symbol of the Green Leaf function tells the room user if the room is operated efficiently.

- Leaf is green  = Energy-optimized operation
- Leaf is red  = Excessive energy consumption

Pressing the leaf symbol returns room control to energy-optimized operation.

The lower half of the device consists of one window for a designation sign. Labels for the operating functions for the given capacitive buttons can be placed in this window. The 8 lower buttons operate the functions. The following electric operating fields can be selected in the configurable Designo room automation system.

### 4 x Light dimming

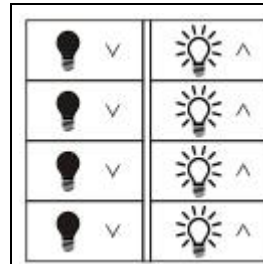

The operator panel manually operate of 4 KNX PL-Link light outputs. This requires 4 horizontal button pairs.

- Switch off + Dim lighting
- Switch on + Make lighting brighter

### 2 x Light dimming 2 x blinds

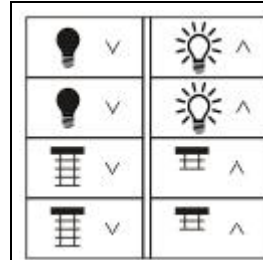

This operator panel manually operates 2 KNX PL-Link light outputs and 2 KNX PL-Link blinds outputs.

This requires 4 horizontal button pairs.

- Switch off + Dim lighting
- Switch on + Make lighting brighter
- Blinds down
- Blinds up

### 4 x Light switching 2 x blinds

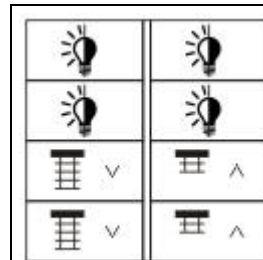

This operator panel manually operates 4 KNX PL-Link light outputs and 2 KNX PL-Link blinds outputs.

Requires 4 individual buttons and 2 horizontal button pairs.

- Switch on/off lighting
- Blinds down
- Blinds up

## Air quality indication

Sensor devices QMX3.P70 and AQR2535NNWQ indicate room air quality (CO<sub>2</sub> concentration) using a multicolor LED (air quality indicator) in green, orange, or red.



The indication can be displayed on all LCD versions as a value or symbol.

**Presence detector  
KNX PL-Link**

The UP 258D12 is both a presence and motion detector. It communicates with the DXR2 over the KNX PL-Link. It is designed for mounting on the ceiling and be targeted at the required detection area thanks to the movable sensor head.



**Figure: Presence detector UP258D12**

**Actuators  
KNX PL-Link**

The VAV compact controllers GDB181.1E/KN and GLB181.1E/KN are deigned to control a variable or constant air flow. The devices communicates with the DXR2 over the KNX PL-Link.



**Figure: VAV actuator**

### Switch for lighting and blinds control KNX PL-Link

The DELTA i-system and DELTA style switch systems communicated with the DXR2 using the bus transceiver module over KNX PL-Link. The button interface UP220/31 integrates conventional switches to the DXR2 over the KNX PL-Link.



**Figure: Light and blinds switch KNX PL-Link**

### Actuators for lighting and blinds KNX PL-Link

The switching actuators for lighting and blinds are available in various forms. In addition to installation in the room automation box, there are also flush mount devices with mounting frames as a switch interface used to plug in buttons from GAMMA i-system and style. There are also flush mount devices (UP) without mounting frames. All these switching actuators communicates with the DXR2 over the KNX PL-Link.



**Figure: Actuators with KNX PL-Link for lighting and shading**

## 2 Connecting to the automation level

A Desigo PXC00-E.D (or another Desigo PXC...-E.D) is used to integrate the configurable Desigo room automation.

The automation station takes over the scheduler system function. Scheduler object in the PXC00-E.D control the room automation central functions and exchanges demand signals with the primary plant.

As option, configurable Desigo room automation with DXR2 can also be integrated in any other BACnet system. The demand signals of the central functions are directly referenced to the automation level.

## 3 Connecting to Desigo CC

### Topology

The system controller PXC00-E.D is preferred for integrating configurable room automation on the Desigo CC management station.

The PXC00-E.D has two main tasks:

- Exchanging demand and supply data with the primary plant
- Running time schedulers

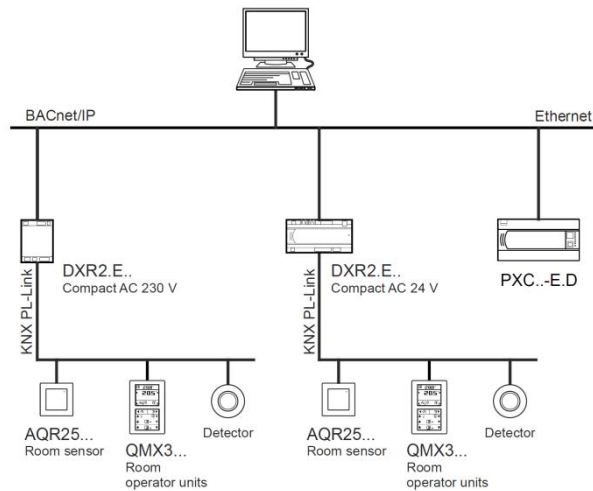

**Figure: Integration of the configurable Desigo room automation system on the Desigo CC management station**

### Operation

Desigo CC runs central operation of Desigo room automation via operating graphics for the room. Desigo CC automatically generates room graphics for Desigo room automation, i.e. no additional engineering required.

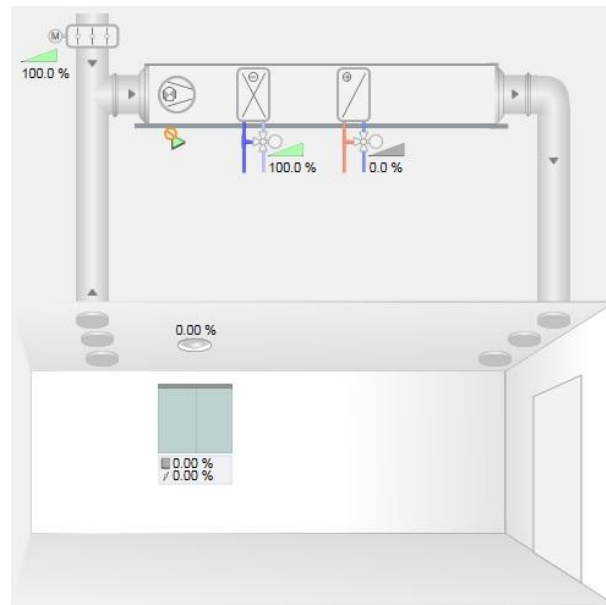

**Figure: Desigo CC operating graphics of a room with fan coil application**

## 4 Applications

Various application types can be used on each DXR2. They contain applications for room conditions, lighting, and shading. It is the I/O mix of the DXR2 automation station that determine characteristics of the application types. Each DXR2 can operate one active and configured application type.

### Preloaded

At least one application type, suitable to the I/O mix is preloaded on each DXR2 automation station. This increases efficiency since there is no download.

### Load

A configurable application type can be replaced on the DXR2 by another application type as needed. This is also true if you want to use a newer version of an application type.

### Template

An application can be saved as a template in the project and reused after configuring. A template is still fully configurable so that functionality can be adapted even on a template.

### Configuration of on-board inputs and outputs

All application types can be configured. The system automatically enables the application function when selecting the on-board device configuration or configuration of KNX PL-Link devices. The sets made by the system can be checked and changed as needed.

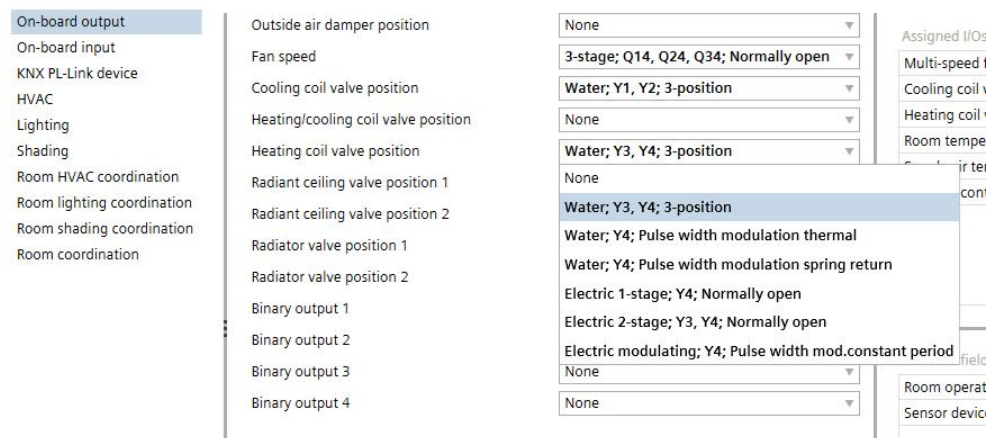

Figure: Example for configuring on-board outputs

### Configuration of KNX PL-Link field devices

All application types provide a selection of supported field devices. They can be selected and configured.

On-board output	Room operator unit device 1	QMX3.P34; General HVAC
On-board input	Room operator unit device 2	None
<b>KNX PL-Link device</b>	Lighting device 1	None
HVAC	Lighting device 2	None
Lighting	Lighting device 3	RL 512/23 - JB 512C23; 1x lighting, switching
Shading	Lighting device 4	<b>RS 510/23 - JB 510C23; 2x lighting, switching</b>
Room HVAC coordination	Lighting pushbutton device 1	UP 510/03; 2x lighting, switching
Room lighting coordination	Lighting pushbutton device 2	UP 510/13; 2x lighting, switching
Room shading coordination	Blinds device 1	RS 525/23 - JB 525C23; 1x lighting, dimming
Room coordination	Trend for blinds command 1	UP 525/03; 1x lighting, dimming
	Blinds device 2	UP 525/13; 1x lighting, dimming
	Trend for blinds command 2	None
	Blinds pushbutton device 1	None
	Blinds pushbutton device 2	None

Figure: Example of selecting KNX PL-Link field devices

### Engineering configured functions and field devices

The parameters can be changed on all configured functions and field devices. The system presets all parameters; they can be changed as needed.

Avail. on AS ▾	Object description ▾	Parameter description ▾	Value ▾	Unit ▾
Filter	Filter	Filter	Filter	Filter
	▼ On-board output			
<input type="checkbox"/>	Variable speed fan	Signal type	0...10 V DC, for I/O	
<input type="checkbox"/>	Variable speed fan	Process value 1	0	%
<input type="checkbox"/>	Variable speed fan	Signal value 1	0	---
<input type="checkbox"/>	Variable speed fan	Process value 2	100	%
<input type="checkbox"/>	Variable speed fan	Signal value 2	10	---
<input type="checkbox"/>	Cooling coil valve position	Startup synchronization	Single close	
<input type="checkbox"/>	Cooling coil valve position	End position synchronization	Single	
<input type="checkbox"/>	Cooling coil valve position	Function command	Ready	
<input type="checkbox"/>	Cooling coil valve position	Rise time from 0 to 100%	1500	1/10s
<input type="checkbox"/>	Cooling coil valve position	Fall time from 100 to 0%	1500	1/10s
<input type="checkbox"/>	Cooling coil valve position	Hysteresis	2	%
<input type="checkbox"/>	Cooling coil valve position	Neutral zone	1	%
<input type="checkbox"/>	Cooling coil valve position	Control action	Direct	

Figure: Application configuration of on-board outputs

### Template for a DXR2 application

Configured DXR2 applications can be saved and reused as templates. Designo room automation already has a set of 30 templates for the DXR2 as examples for configurable room applications.



## 5 User roles

DXR2 automation stations supports various user roles in the system. A user name and password can be assigned to each user role. Access roles and passwords are required to connect to the DXR2 automation station.

We suggest the following user roles as a standard in DXR2. They can of course be customized:

- Administrator
- Balancer
- Specialist
- Desigo Basic Operator

## 6 Web server

<b>Access via web browser</b>	The DXR2 automation station has an integrated web server. Access to this web server is password protected and takes place via the automation station IP address. A web browser is required for access.
<b>Online operation and monitoring</b>	The DXR2 web server permits online access to all configured BACnet data points and their properties to the applicable DXR2 automation station. The data points and properties can be operated in the web server and/or monitored.
<b>User role view</b>	The various user roles ensure that the current user can only operate and monitor relevant data points on the web server.
<b>Favorites</b>	The web server has a favorites view that compiles the most important data points for communication and servicing HVAC, lighting, and blinds applications.

## 7 Rooms and room segments

### Room

Each DXR2 automation station can control one room. One segment also belongs to the room in each DXR2. The DXR2 includes the control function for the room as well as control function for the associated room segment. Room control includes all functions that apply to the entire room including Green Leaf or, for example, room temperature controller. The room segment includes all field devices and controls and controllers for the individual disciplines, e.g. the room operator unit, control of VAV actuators, or chilled ceiling control. A group ensures the connection between room function and room segment function.

So that multiple DXR2 can be combined to form a larger room. They can also be separated again at a later date to guarantee full flexibility.

### Room segment

Each DXR2 includes, in addition to the control for the room, control for the associated room segment. A room segment is the smallest indivisible element in the building. The room segment includes all field devices and controls and controllers for the individual disciplines, e.g. the room operator unit, control of VAV actuators, or chilled ceiling control. Each room segment requires a connection to room control. Room control can take place on the same DXR2 or another DXR2.

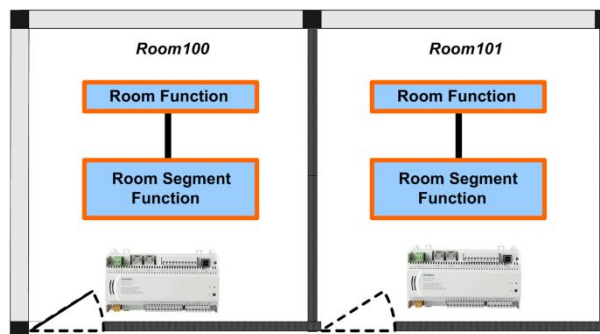

Figure: Two rooms with one DXR2 automation station each for room automation

### Multisegment

Switching multiple DXR2s to one large room is referred to as a multisegment application. One of the DXR2 assumes room control for all switched DXR2s. Room control is disabled on the other DXR2s. In addition, all room segment functions, on the various DXR2s, are connected through grouping with the still enabled room function of the one DXR2.

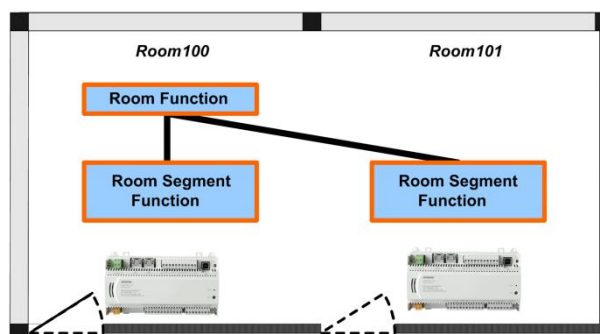

Figure: Multisegment application with 2 DXR2 automation stations combined to form one room

The given room function is once again enabled when dividing up a large room to various smaller rooms and connected to the associated room segment functions.

The system ensures that there is only one active room function per room and supports the switching of room segments with the same application types. The following combinations are examples of possible multisegment applications for one DXR2 with one fan coil application type:

Combination	DXR2	DXR2
1	Fan coil application	Fan coil application
2	Fan coil application with chilled ceiling and/or radiator application	Fan coil application with chilled ceiling and/or radiator application
3	Fan coil application with chilled ceiling and/or radiator application	Fan coil application
4	Fan coil application with chilled ceiling and/or radiator application	Chilled ceiling and/or radiator application
5	Chilled ceiling and/or radiator application	Chilled ceiling and/or radiator application

The following combinations are examples of possible multisegment applications for one DXR2 with one VAV application type:

Combination	DXR2	DXR2
1	VAV application (supply and extract air)	VAV application (supply and extract air)
2	VAV application (supply air and/or extract air) with chilled ceiling and/or radiator application	VAV application (supply air and/or extract air) with chilled ceiling and/or radiator application
3	VAV application (supply air and/or extract air) with chilled ceiling and/or radiator application	VAV application (supply and extract air)
4	VAV application (supply air and/or extract air) with chilled ceiling and/or radiator application	Chilled ceiling and/or radiator application
5	Chilled ceiling and/or radiator application	Chilled ceiling and/or radiator application

Combinations of one DXR2 with fan coil application and one DXR2 with VAV application cannot be configured.

---

<b>Automatic control logic for HVAC</b>	<p>Multisegment applications always ensure full coordination of individual electrical and mechanical installations of jointly used room control in the room segment. All HVAC controllers (e.g. temperature or fresh air) is automatically managed by the system when rooms are combined or separated and interconnected with the correct segments.</p> <p>On VAV plants, supply air and extract air volume is correctly coordinated over all segments to achieve the preset setpoints for the room.</p> <p>In other words, it is possible to combine multiple supply air VAVs, with multiple extract air VAVs to form one room. A maximum of one supply air and extract air VAV can be connected to each DXR2 in this multisegment application.</p> <p>The DXR2 responsible for room control recognizes a fault to one VAV actuators or DXR2 controller in a multisegment application. If physically possible, the still active VAV actuators will attempt to compensate in this case for the fault VAV actuators.</p>
<b>Room operator units</b>	<p>Room operator units can be connected to various DXR2s on multisegment applications. All displays and entries on room operator units are synchronized as soon as the DXR2s are combined to one large room.</p>
<b>Assignment of light and blind switches</b>	<p>Existing assignments of light and blind switches are retained when merging rooms to a multisegment applications. The same applies to divided up the rooms. The assignment can be reconfigured within a room as needed.</p>
<b>Rearrange rooms with Desigo CC</b>	<p>The Desigo CC management station can also be used to combine or divide rooms. Desigo CC permits the user to combine the HVAC electrical and mechanical installations to one room or divided them up again. Existing assignments to light and blinds switches are unaffected.</p>

## 8 Central function with groups

### Central function

A central function implements central control functions and coordinated demand and forced signals. A central function acts through a group in the planned rooms or wings. The central function can also collect and compile, via the group, demand signals or state signals from the wings or rooms.

Hidden behind the central control functions are system functions such as operator interventions (via BACnet clients, e.g. a management station or via local operator units), schedulers, automatic reactions, data from a weather station, etc.

Central functions influence:

- Room operating mode (occupancy and use in room).
- HVAC control via various setpoint requirements dependent on the room operating mode.
- HVAC setpoints via a weather-dependent adjustment.

Grouping can still be used to coordinate demand, operating, and forced signals, i.e.:

- Request signals for hot water distribution (heating circuit).
- Request signals for chilled water distribution (cooling circuit).

### Control of central functions

Various source influence and control central functions:

- An external system or third-party device
- System user via BACnet client, e.g. Desigo CC
- Building user via BACnet client or local operator unit
- Scheduler or reaction program
- Commands from a higher, central control.

After evaluating signals and command, they are distributed via group by the group master to the group members.

### Groups

A group combine various rooms, the entire building, a wing, floor, or facade. One group member exists for the various category that forwards the resulting information to all associated group members.

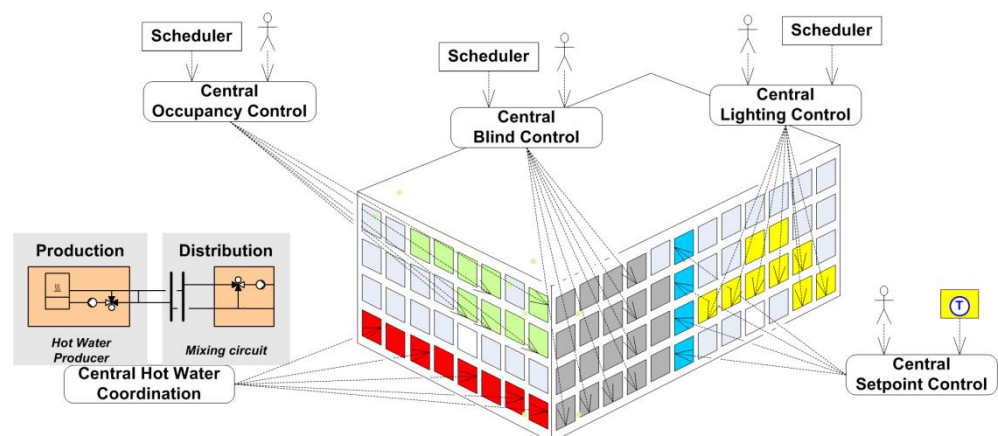

Figure: Building with central control functions

---

Grouping functions help structure and centrally control large numbers of different system elements and data. Grouping can take place by organizational, geographic, functional, or cross-discipline criteria. Group cooperation supports data exchange between central control functions and individual system elements.

**Hierarchical groups**

A group master can for its part be a group member of a superposed group master.

**Grouping on multisegment applications**

The group function is also used to combine multiple DXR2s to large rooms to coordinate room segments on the individual automation stations.

## 9 Alarms

The DXR2 has internal alarms. The alarm concept for Desigo room automation distinguishes between system alarms and process alarms.

### 9.1 System alarms on DXR2

System alarms monitor the reliability of data points or the state of networked devices. This always occurs as a common alarm for the room, the room segment, or central function. This information can be read and displayed via BACnet client, e.g. a management station.

#### Notes

- Monitoring KNX PL-Link buttons is not possible.
- With regard to system limits (number of Event Enrollment objects) for a room automation station: The state of networked devices is normally only monitored if such a request exists.
- The state of networked devices is monitored indirectly via reliability of their data points (common alarm).

### 9.2 Preconfigured system alarms

#### Common alarm

A common alarm is formed by default in the room, room segment, and central function based on reliability monitoring.

#### Monitoring operating state

KNX PL-Link components can be connected to the room automation station. The operating state of the bus is monitored via the Event Enrollment object "PL-Link\_1'EE". The operating state of the room automation station is also monitored by default.

### 9.3 Process alarms on free inputs

Inputs and outputs can be configured as free inputs on all DXR2s. This permits the querying of unused input and output switching states or directly controlling another device over BACnet. The available or free inputs can be monitored with a process alarm.

The monitoring function must be configured to enabled these alarms.

Description	Default value
Monitoring binary input 1...n 0:None 1:Active	0:None
Monitoring analog input 1...n 0:None 1:Active	0:None

The enable, limit values, and description text must also be configured for each configured monitor.



**Binary input**

Description	Name	Default value
Monitoring binary input 0:Yes 1:No	Enable event detection	1:No
State that trigger the alarm. 0:Active 1:Inactive	Event parameters	0:Active
Time delay for alarm	Time delay	0 [s]
Alarm description text	Description	Monitoring binary input n

**Analog input**

Description	Name	Default value
Monitoring analog input 0:Yes 1:No	Enable event detection	1:No
State that trigger the alarm.	High limit	0
State that trigger the alarm.	Low limit	0
Time delay for alarm	Time delay	0 [s]
Neutral zone, covering the hysteresis between alarm/not alarm	Nz	0

**Note**

The applicable system limits must be observed.

## 9.4 Time response to system and process alarms

**DXR2**

The common alarm in the application program on the room automation station checks the reliability of the data points in each program cycle. The result is outputted without delay from the common alarm data point.

Data points from networked devices are subject to additional delays based on the typical properties of the bus in question.

**KNX PL-Link**

A change in reliability of a KNX PL-Link data point is displayed after ca. 31 minutes. The last value remains.

The automation station queries the state of devices on the bus every 15 minutes. If a fault exists and it still remains after the next query (after an additional 15 minutes), the field devices object is set to the corresponding state. A shorter update period is not possible.

## 10 Trends

Desigo room automation provides a series of trends in each room. Trends are not enabled by default. The following trends can be enabled for each room (through configuration):

- Trend room temperature
- Trend room air quality
- Trend relative room air humidity
- Trend room operating mode
- Trend blinds command

The enable and trend type must be configured for each enabled trend.

Description	Name	Default value
Trend description text	Description	Trend for ...
Type of trend 0: Change-of-Value (COV) 1: Polled	Logging type.	Queried.
Polling interval	Logging interval	90 [s]

This information can be read and displayed via BACnet client, e.g. a management station.

# 11 Control function

## 11.1 Room operating modes

The operating states Comfort, Pre-Comfort, Economy, and Protection are available to the application functions on the DXR2 automation station. The room operating modes apply for the entire room and are superposed for the three disciplines HVAC, lighting, and shading. In other words, the response of HVAC, lighting, and blinds applications are taken from it. The response can be configured for each room and each discipline. The response for any one discipline to a change in operating mode can also be configured.

<b>Comfort</b>	Comfort is the operating mode in an occupied room. The room temperature is within the Comfort range. The room controller works in the heating and cooling sequence with the effective Comfort setpoints. Lighting control is enabled and the blinds automatic ensures anti-glare.
<b>Pre-Comfort</b>	Pre-Comfort is the operating mode during regular building occupancy, but in an unoccupied room. A scheduler enables this operating mode by default. The room user or automatic switches to the Comfort state and back during occupancy. In this operating mode, HVAC control uses setpoints that are slightly above the Comfort setpoint for heating and slightly below for cooling. Lighting control is disabled. Blind automatic is set to anti-glare in anticipation of pending occupancy.
<b>Economy</b>	Economy is the operating mode outside building occupancy with setback level. In the Economy room operating mode, HVAC control uses setpoints that are slightly under the effective Pre-Comfort setpoint for heating and slightly above for cooling. During night setback or over the weekend, the scheduler can control to the Economy state and those strongly lower energy supply to the room. Lighting control is disabled in this operating mode and the blinds are automatically deployed to an energy-efficient position.
<b>Protection</b>	If the building is unoccupied over an extended period of time (e.g. no renter, vacation), the temperature setpoints can be reduced or raised even more so that the building and all equipment are protected against heat or cold at any time. In this operating mode, lighting control is disabled and the blinds are closed.

## 11.2 Room operating mode determination

The present operating mode of the room depends on the central scheduler and local influences such as the room operator unit.

<b>Presence control by room operator unit</b>	<p>DXR2 applications the support the use of the presence button on the QMX3 room operator unit as a presence function:</p> <p>The application changes from Automatic to Comfort state when pressing the presence button. The response of the room operating mode in the applicable can be configured for disabling the button. The room operating mode returns to Automatic mode with the default settings. As an option, the time can start when pressing the button that switches the mode back to automatic after 120 minutes (can be configured).</p>
---	---

### Temporary Comfort extension on the room operator unit

The presence button on the QMX3 room operator units can also be used as a temporary presence extension:

If the scheduler requires the Comfort operating mode, activating the presence button can extend Comfort for 120 minutes (default setting) even if the scheduler already changed to Pre-Comfort or Economy. Repeated pressing of the temporary presence extension, reset the time to the starting value and the room remains in the Comfort state for another 120 minutes.

### Control using the scheduler (on PXC00-E.D)

The configurable Desigo System does not provide a scheduler to DXR2 automation stations. It can be created, however, on a PXC00-E.D (or other Desigo PXC...-E.D) and combined with central functions of the configurable Desigo System.

As option, schedulers from BACnet third-party devices can be used to control rooms or central functions.

The scheduler for room occupancy controls the operating mode of a room or group of rooms. Each renter or area in a building can define its own occupancy and non-occupancy times and influence in this way energy consumption.

The scheduler consists of one periodically controlled weekly program and an exception day (holiday and vacation program) that overwrites the weekly program.

Under normal operations, the scheduler switches from operating modes Pre-Comfort to Economy (unoccupied) as the occupancy times preset by the operator. Comfort mode is enabled locally by pressing the presence button on the room operator unit (occupied).

The example below illustrates a scheduler program for three possible building occupancy states and the preset, actual operating mode. You can configure the DXR2 to adapt the response:

Building occupancy state	Description	Room operating mode
Building used	Full availability of all plants. Building enabled for use. Impact of schedulers: Room operator units are enabled.	per scheduler, room occupancy or room operator unit
Building not used	Reduced availability of the plants. Impact of schedulers: Room operator units are locked. Use: No building occupancy temporarily planned. The building must reach the Comfort temperature within hours.	Economy
Building Protection	Setpoints are at levels required to protect the building. Impact of schedulers: Room operator units are locked. Use: Extended building vacancy.	Protection

## 11.3 Plant operating mode determination

The present operating state of the HVAC plant in a room depends on room operating mode, central supply signals, and local influences. Local influences here include window contact or presence detector. In addition to room operating modes Comfort, Pre-Comfort, Economy, and Protection, there is states Night cooling, boost heating, and rapid cooling for the plant operating mode. The three additional operating modes are controlled from the central functions and are used to optimize energy and comfort.

### Night cooling

The plant operating mode cools a room using cooling outside air. The central function sends a "Night cooling request" to the group member rooms. The decision as to whether night cooling makes sense and is energy efficient is made at the central function. Various coordination signals between the primary plant and room automation do the following via central functions

- Switch on the fans,
- Set the mixed air dampers to 100% outside air,
- Lock all other equipment including heating coils, cooling coils, humidifier,
- And set the VAV boxes in the room to a defined value.

Night cooling only occurs under the following conditions:

- The room is vacant (Economy or Protection).
- The outside temperature is above an adjustable setpoint of 9 °C.
- The temperature difference is sufficiently large for cooling, i.e. room temperature – outside temperature > 7 K.
- The temperature deviation from room temperature and temperature setpoint is sufficiently large, i.e. room temperature > room setpoint + 2 K.

### Free cooling

The function free cooling to take advantage of cooling generated without effort to cool the rooms to a room temperature setpoint. Dew point compensation is still available for the chilled water temperature setpoint dependent on active dew point detector via the grouping function.

This supply chain is continued accordingly, in other words chilled water generation (chillers, refrigeration machines, etc.) are also controlled based on demand.

### Preheating

The central functions can trigger the preheating function to heat up a room at end of the night setback period as quickly as possible to the Pre-Comfort setpoint.

### Precooling

To prepare an unoccupied room in Economy or Pre-Comfort for occupancy as quickly as possible or take optimum advantage of available cooling energy from the primary plant, can be resolved by the central functions, function precooling.

### Start optimization

Start optimization means that the room is heated in advance, so that the desired Comfort conditions are met at the start of occupancy.

One or more rooms are defined as a reference room in the configurable Desigo system. The room temperature and operating mode for the reference room is then distributed via a central function to all assigned rooms.

**Control using window contact**

Heating and cooling output is reduced to a minimum when a window is opened. The DXR2 automation station always switches to Protection operating mode. The window contact is connected directly to the DXR2 digital input.

The table below displays the actual operating mode based on window contact:

Window contact state	Plant operating mode
Window closed	No effect
Window open	Protection

**Control using a presence detector**

A presence detector detects the presence of people in a room. It controls the operating mode of a DXR2 during occupancy. Outside building occupancy, it is locked for HVAC and blinds functions. Light always reacts to the presence detector. The settings can be configured individually for each room.

The presence detector has two states:

State	Description
Occupied	Room is occupied, DXR2 switches room operating mode to Comfort.
Unoccupied	Room is occupied, DXR2 switches plant operating mode to Pre-Comfort.

Together with supply signals night cooling, precooling, and preheating, result in the following plant operating mode.

Room operating mode	Presence	Window contact	Night cooling signal from supply	Precooling from supply	Preheating from supply	Resulting plant operating mode
-	-	Open	-	-	-	Protection
Protection	-	Closed	-	-	-	Protection
Economy	-	Closed	False	False	False	Economy
	-	Closed	True	False	False	Night cooling
	-	Closed	-	-	True	Heat up
	-	Closed	-	True	False	Cool down
Pre-Comfort	-	Closed	-	True	-	Cool down
	-	Closed	-	False	-	Pre-Comfort
	Present	Closed	-	-	-	Comfort
	Absent	Closed	-	False	-	Pre-Comfort
	Absent	Closed	-	True	-	Cool down
Comfort	-	Closed	-	-	-	Comfort
	Present	Closed	-	-	-	Comfort
	Absent	Closed	-	False	-	Pre-Comfort
	Absent	Closed	-	True	-	Cool down

## 11.4 Room controller and setpoints

The DXR2 applications possess 5 different room controls:

- Temperature control for heating
- Temperature control for cooling
- Air quality control
- Air volume flow tracking control (for positive or negative pressure control in room for VAV)
- Humidity control (for local dehumidification via the cooling coils on fan coils)

Enabled controllers communicate with one another. This ensures the simultaneous use of multiple controllers in the same room.

### Sensor as feedback

Each enabled controller in the room requires a measured value provided to control via a sensor.

### 11.4.1 Temperature setpoints

Each room has 8 different room temperature setpoints for the room temperature: One heating and cooling setpoint each for operating modes Comfort, Pre-Comfort, Economy, and Protection. The setpoints can be configured on the DXR2. The heating and cooling setpoints for Pre-Comfort correspond to a configurable difference for comfort setpoints.

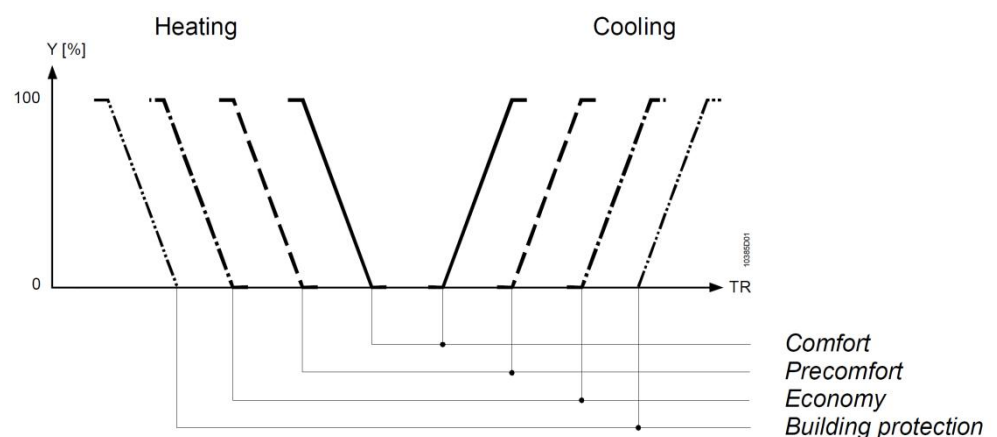

Y Output signal (valve or damper actuator)  
TR Room temperature

**Figure: Heating and cooling setpoints for various operating modes**

Depending on the actual room operating mode, one setpoint each is selected for heating and cooling and used for control.

### Setpoint setting on room operator unit

The room temperature setpoints can be operated on the room operator unit.

An increase in room temperature acts on:

- Both Comfort setpoints (heating/cooling)
- Both Pre-Comfort setpoints (heating/cooling)

An decrease in room temperature acts on:

- Both Comfort setpoints (heating/cooling)
- Both Pre-Comfort setpoints (heating/cooling)

You can set the setpoint display as well as possible intervention by the room user when configuring the room operator unit.

The room operator unit cannot influence the heating and cooling setpoints for Economy or Protection.

### Comfort setpoints as seasonal compensation

The Comfort setpoints for temperature control in the room is mapped in the central function for seasonal compensation. The central seasonal compensation (setpoint shift based on outside temperature) causes a gradual increase in room temperature as a function of the outside temperature. This prevents too great a difference between the indoor and outdoor temperature in summer and increases overall comfort in winter.

These values are transferred to the rooms via a group. In the room, the transferred values are displayed on these two BACnet object:

Description	Name
Heating setpoint for Comfort	SpHCmf
Cooling setpoint for Comfort	SpCCmf

### Comfort setpoints directly for the room

A default command can be made on the BACnet objects listed above if setpoints for Comfort are to be set directly in the room without influence from the central function:

Description	Name	Default value
Default command for heating setpoint for Comfort	DefCmd for SpHCmf	21 °C
Default command for cooling setpoint for Comfort	DefCmd for SpCCmf	24 °C

### Setpoint configuration

The setpoints can be configured on the DXR2.

Description	Name	Default value
Heating setpoint Delta for Pre-Comfort	DSpHPcf	1 K
Heating setpoint for Economy	SpHEco	15 °C
Heating setpoint for Protection	SpHPrt	12 °C
Cooling setpoint Delta for Pre-Comfort	DSpCPcf	1 K
Cooling setpoint for Economy	SpCEco	35 °C
Cooling setpoint for Protection	SpCPrt	40 °C

### Setpoint setting in Desigo CC

The Comfort, Economy and Precomfort setpoints can be adjusted separately for each room for the heating and cooling sequences centrally from the Desigo CC management station. Adjusting the Comfort setpoint also changes the Pre-Comfort setpoint.

The setpoints Economy and Protection as well as the set difference for Pre-Comfort values can also be adapted in Desigo CC to the individual DXR2 automation stations.



## 11.4.2 Temperature control: Direct or cascading

DXR2 applications support two forms of temperature control: Direct temperature control and room supply air cascade.

**Direct temperature control** On direct room temperature control the room controller directly calculates the output signal (0...100%) for the aggregates from the measured room temperature.

**Room supply air cascade** Room supply air cascade quickly achieves the room temperature setpoint. The room controller calculates a setpoint from the room temperature as measured at the air outlet of the air system. The temperature can be limited to prevent the inflow of unpleasantly cool or warm air into the room.

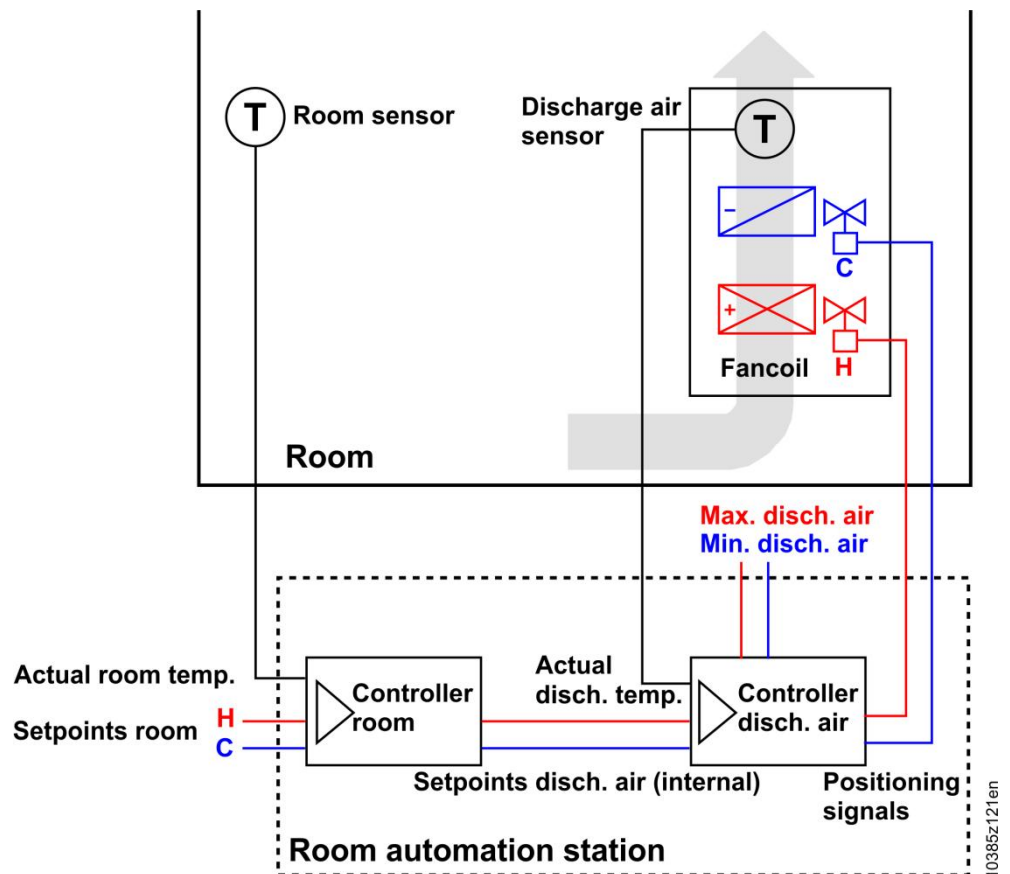

Figure: Plant diagram for supply air cascade control

10385z121en

### 11.4.3 Air quality setpoints

Each room has 4 different setpoints for air quality: One each for operating modes Comfort, Pre-Comfort, Economy, and Protection. The setpoints can be configured on the DXR2.

A setpoint is selected and used for control depending on the actual room operating mode.

#### Setpoint configuration

The air quality setpoints can be configured on the DXR2.

Description	Name	Default value
Room air quality setpoint for Comfort	SpAQualRCmf	900 ppm
Room air quality setpoint for Pre-Comfort	SpAQualRPcf	1100 ppm
Room air quality setpoint for Economy	SpAQualREco	1500 ppm
Room air quality setpoint for Protection	SpAQualRPrt	1500 ppm

### 11.4.4 Setpoints for air volume tracking

Both the room pressure operating mode as well as overflow air volume flow can be configured to track air volume flow:

#### Setpoints for air volume tracking

Description	Name	Default value
Room air operating mode 1:Neutral 2:Positive pressure 3:Negative pressure	PRMod	1:Neutral
Overflow air volume flow	AirFITrn	10 m <sup>3</sup> /h

### 11.4.5 Setpoints for relative humidity

Each room has 4 different setpoints for relative humidity: One each for operating modes Comfort, Pre-Comfort, Economy, and Protection. The setpoints can be configured on the DXR2.

A setpoint is selected and used for control depending on the actual room operating mode.

#### Setpoints for relative humidity

The setpoints for relative humidity can be configured on the DXR2:

Description	Name	Default value
Relative room air humidity setpoint for Comfort	SpHuRelRCmf	65% r.h.
Relative room air humidity setpoint for Pre-Comfort	SpHuRelRPcf	70% r.h.
Relative room air humidity setpoint for Economy	SpHuRelREco	80% r.h.
Relative room air humidity setpoint for Protection	SpHuRelRPrt	90% r.h.

## 11.4.6 Room controller output signals

### Room controller output signals

The room controllers forward their output signals (0...100%) to all impacted aggregates in all segments of the room. For example, the heat controller, that control room temperature, always forwards its output signal to all enabled aggregates including radiators, heated ceilings, and heating coils. In control for the individual aggregates, the 0...100% signal is always converted to the configured output signal.

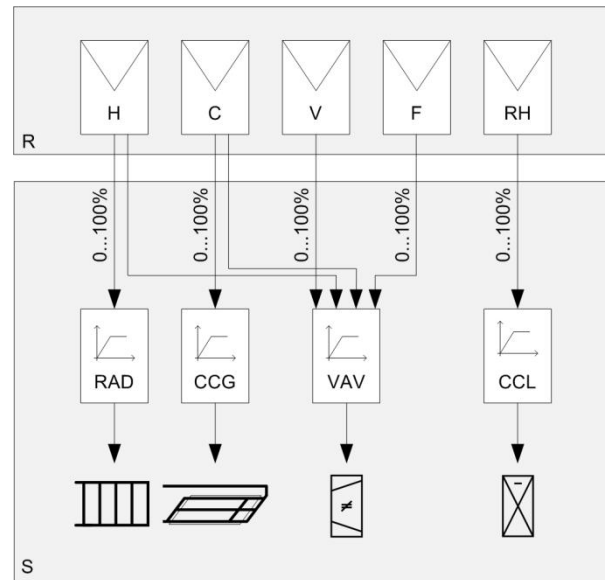

Figure: Examples of room controllers with 0...100% output signal to the aggregate controllers

Key:

R	Room	S	Segment or segments
H	Heating controller	RAD	Radiator controller
C	Cooling controller	CCG	Chilled ceiling controller
V	IAQ controller	VAV	Controller for VAV actuator
F	Air volume flow tracking controller	CCL	Cooling coils controller
RH	Humidity controller		

### Control sequences for temperature control

The sequence for each heating/cooling aggregate can be configured in temperature control of the DXR2 automation station. There is one sequence for heating and one sequence for cooling.

The devices are then controlled in the cooling or heating sequence based on room temperature and setpoint. The next sequence element is immediately controlled if a device is currently unavailable (fault or out of service).



Figure: Sequence of control sequences for a VAV application

**Fan coil application**

The control sequences for temperature control in a fan coil application can be adapted through the following parameters:

Description	Name	Default value
Outside damper cooling sequence	DmpOaCSeq	1
Radiated ceiling cooling sequence	RcgCSeq	2
Heating/cooling coils cooling sequence	HCclCSeq	3
Cooling coil cooling sequence	CclCSeq	4
Fan cooling sequence	FanCSeq	5
Radiator heating sequence	RadHSeq	1
Radiated ceiling heating sequence	RcgHSeq	2
Heating/cooling coils heating sequence	HCclHSeq	3
Heating coils heating sequence	HclHSeq	4
Fan heating sequence	FanHSeq	5

**VAV application**

The control sequences for temperature control in a VAV application can be adapted through the following parameters:

Description	Name	Default value
Radiated ceiling cooling sequence	RcgCSeq	1
Heating/cooling coils cooling sequence	HcclCSeq	2
Cooling coil cooling sequence	CclCSeq	3
VAV cooling sequence	VavCSeq	4
Radiator heating sequence	RadHSeq	1
Radiated ceiling heating sequence	RcgHSeq	2
Heating/cooling coils heating sequence	HCclHSeq	3
Heating coils heating sequence	HclHSeq	4
VAV heating sequence	VavHSeq	5

**Fan-Powered Box**

The control sequences for temperature control in a fan-powered box application can be adapted through the following parameters:

Description	Name	Default value
Radiated ceiling cooling sequence	RcgCSeq	1
Heating/cooling coils cooling sequence	HcclCSeq	2
Cooling coil cooling sequence	CclCSeq	3
Fan cooling sequence	FanCSeq	4
VAV cooling sequence	VavCSeq	5
Radiator heating sequence	RadHSeq	1
Radiated ceiling heating sequence	RcgHSeq	2
Heating/cooling coils heating sequence	HCclHSeq	3
Heating coils heating sequence	HclHSeq	4
Fan heating sequence	FanHSeq	5
VAV heating sequence	VavHSeq	6

### 11.4.7 Activate aggregates based on plant operating mode

You can configure how a room is cooled or heated for the plant operating mode on DXR2. The following options are available separately as setting values for heating and cooling:

- Heating with radiators (radiator/heated ceiling)
- Heating with air handling only (heating coils, electric reheaters)
- Heating with both
- Cooling with radiators only (chilled ceiling)
- Cooling with air handling only (cooling coils)
- Cooling with both

Description	Name	Default value
Heating Comfort 1:None 2:Radiators 3:Air handling units 4:Radiator & air handling	CmfCnf	4:Radiator & air handling
Heating Pre-Comfort	PcfCnf	4:Radiator & air handling
Heating Economy	EcoCnf	4:Radiator & air handling
Heating Protection	PrtCnf	4:Radiator & air handling
Heating warm up	WarmUpCnf	4:Radiator & air handling
Cooling Comfort	CmfCnf	4:Radiator & air handling
Cooling Pre-Comfort	PcfCnf	4:Radiator & air handling
Cooling Economy	EcoCnf	4:Radiator & air handling
Cooling Protection	PrtCnf	4:Radiator & air handling
Cooling cool down	CoolDnCnf	4:Radiator & air handling
Cooling free cooling	FreeCCnf	4:Radiator & air handling

## 11.4.8 Controller operating mode for heating and cooling aggregates based on the plant operating mode

For the room operating modes, the controller operating mode can be configured on DXR2 for all heating and cooling aggregates.

Description	Name	Default value
Cooling coils in Comfort 0:Modulating 1:2-position	CoilCmf	0:Modulating
Coil coils in Pre-Comfort	CoilPcf	0:Modulating
Coiling coils in Economy	CoilEco	0:Modulating
Cooling coils in Protection	CoilPrt	0:Modulating
Coiling coils in cool down	CoilCoolDn	0:Modulating
Chilled ceiling in Comfort	RadDevCmf	0:Modulating
Chilled ceiling in Pre-Comfort	RadDevPcf	0:Modulating
Chilled ceiling in Economy	RadDevEco	0:Modulating
Chilled ceiling in Protection	RadDevPrt	0:Modulating
Chilled ceiling in cool down	RadDevCoolDn	0:Modulating
Heating coils in Comfort	CoilCmf	0:Modulating
Heating coils in Pre-Comfort	CoilPcf	0:Modulating
Heating coils in Economy	CoilEco	0:Modulating
Heating coils in Protection	CoilPrt	0:Modulating
Heating coils in warm up	CoilWarmUp	0:Modulating
Radiator & heated ceiling in Comfort	RadDevCmf	0:Modulating
Radiator & heated ceiling in Pre-Comfort	RadDevPcf	0:Modulating
Radiator & heated ceiling in Economy	RadDevEco	0:Modulating
Radiator & heated ceiling in Protection	RadDevPrt	0:Modulating
Radiator & heated ceiling in warm up	RadDevWarmUp	0:Modulating

### Controller operating mode modulating

The controller operating mode modulating controls based on one PID controller (amplification, integral time, etc.).

### Controller operating mode 2-position

Controller operating mode 2-position controls the output signal based on an hysteresis and delay.

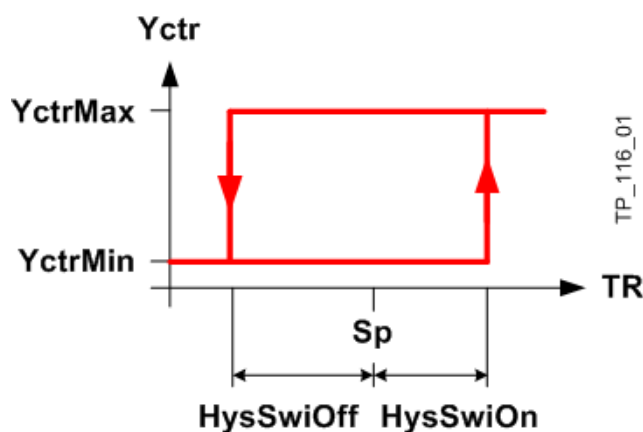

Figure: Curve for controller operating mode 2-position

Key:

HysSwiOn	Switch-on value	TR	Room temperature
HysSwiOff	Switch-off value	YctrMax	Controller output maximum
SP	Setpoint	YctrMin	Controller output minimum
SwiDly	Delay when switching		

### 11.4.9 Stage controller of aggregates

A stage controller can also be configured on the DXR2 for each aggregate regardless of the room operating modes.

Description	Name	Default value
Controller type 0:PID controller 1:Stage controller	CtrType	0:PID controller

Controller values for hysteresis, delay, and number of stages can be configured.

Description	Name	Default value
Switch-on value	HysSwiOff	0.5 K
Switch-off value	HysSwiOn	0.5 K
Delay when switching	SwiDly	5 Min
Number of stages	NumSts	1

The following example illustrate the response of the output for a 4-position controller compared to room temperature.

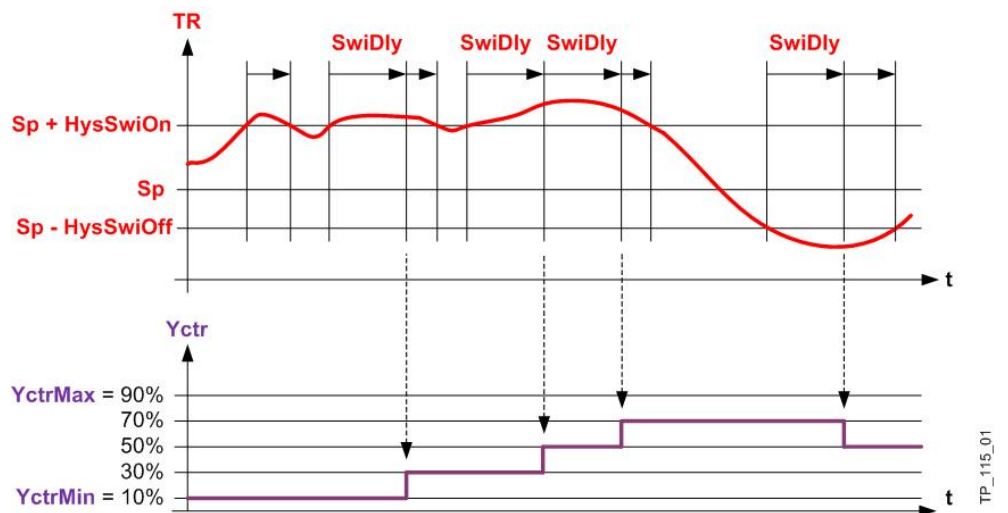
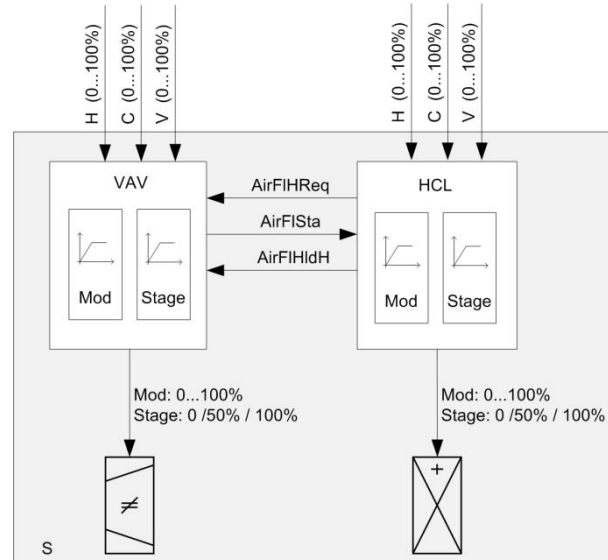

Figure: Example of a 4-stage controller

TP\_115\_01

## 11.5 Output signals to the aggregates

The room controllers forward their output signal to the aggregate signal converter as 0...100% signal. Each aggregate possess a signal converter that always converts the 0...100% signal to the aggregate's configured output signal. Demand and locking signals are coordinated between the individual controls with the converters to ensure the proper functioning of the application.



**Figure: Examples of aggregate converters with locking and demand signals as well as output signals**

Key:

AirFIHIdH	Locking signals for electric heating coils to prevent the electric heating coils from overheating when the fan coil plant is switched off (overrun).	HCL	Heating coil control
AirFIHReq	Demand signal for heating coils to VAV requiring air volume for heating	S	Segment or segments
AirFISta	Locking that ensures that heating coils can only be enabled if volume flow is available.	V	IAQ controller output
C	Cooling controller output	VAV	VAV actuator control
H	Heating controller output		



### 11.5.1 Staged output

The stage converter associated with staged aggregates, e.g. a 3-stage ventilator, is always enabled. The threshold values for the stage converter are fixed in DXR2 and cannot be changed. The stages switch based on the room controller in %.

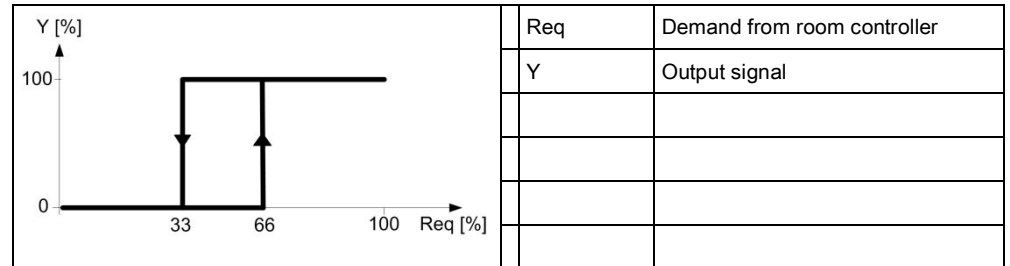

Figure: Characteristic curve and switching points of the 1-stage aggregate converter

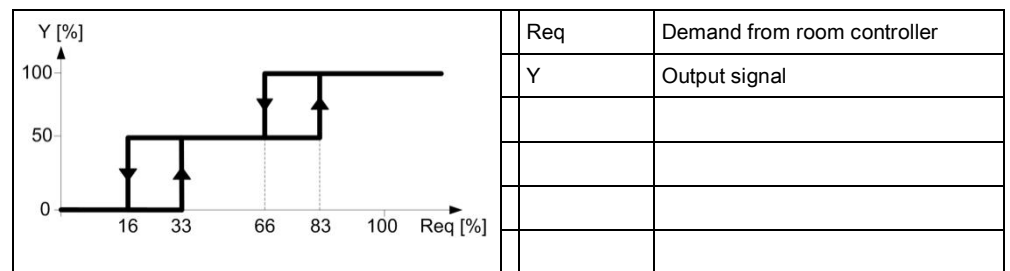

Figure: Characteristic curve and switching points of the 2-stage aggregate converter

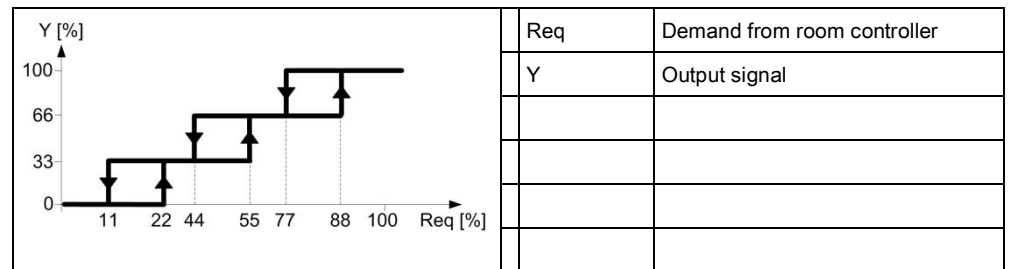

Figure: Characteristic curve and switching points of the 3-stage aggregate converter

### 11.5.2 Modulating output

The associated modulating converter is always enabled on aggregates without stages.

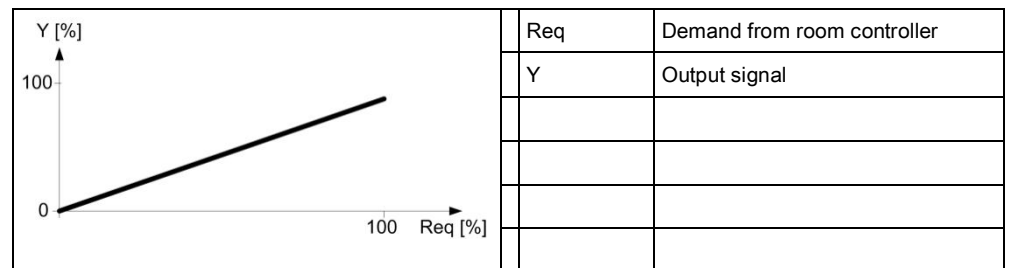

Figure: Characteristic curve of the modulating aggregate converter

## 12 Operation in room

The configurable Desigo room automation and control system supports QMX3 room operator units for wall mounting. The plug-and-play devices, featuring KNX PL-Link communications, can acquire, depending on the type, the room temperature, humidity, or air quality. Types are available for the various use cases both with and without display and operating elements. So that you can compile customized operating concepts ranging from merely acquiring measured values with indication (sensors), to comprehensive display and operation of room conditions (HVAC), or combining the same with lighting and shading to create a custom operating concept. The QMX3 for flush mounting is also supported by DXR2 with a selection of preconfigured display templates.



Figure: Room operator units QMX3

### Green Leaf

The leaf symbol of the Green Leaf function tells the room user if the room is operated efficiently.

- Leaf is green 🍃 = Energy-optimized operation
- Leaf is red 🍁 = Excessive energy consumption

Pressing the leaf symbol returns room control to energy-optimized operation.

The lower half of the device consists of one window for a designation sign. Labels for the operating functions for the given capacitive buttons can be placed in this window. The 8 lower buttons operate the functions. The following electric operating fields can be selected in the configurable Desigo room automation system.

### 4 x Light dimming

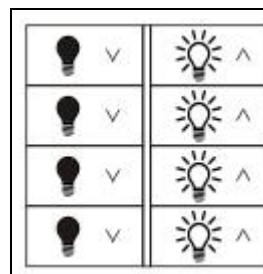

The operator panel manually operate of 4 KNX PL-Link light outputs. This requires 4 horizontal button pairs.

- Switch off + Dim lighting
- Switch on + Make lighting brighter

**2 x Light dimming  
2 x blinds**

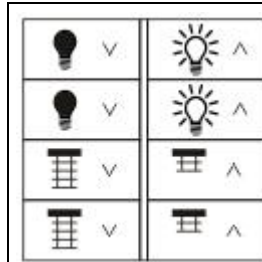

This operator panel manually operates 2 KNX PL-Link light outputs and 2 KNX PL-Link blinds outputs.

This requires 4 horizontal button pairs.

- Switch off + Dim lighting
- Switch on + Make lighting brighter
- Blinds down
- Blinds up

**4 x Light switching  
2 x blinds**

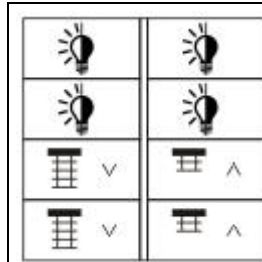

This operator panel manually operates 4 KNX PL-Link light outputs and 2 KNX PL-Link blinds outputs.

Requires 4 individual buttons and 2 horizontal button pairs.

- Switch on/off lighting
- Blinds down
- Blinds up

## 12.1 Green Leaf

Desigo TRA offers room users interaction with regard to energy management via an innovative operating and displaying concept. Pressing the Room Green Leaf symbol returns room control to energy-optimized operation without sacrificing on comfort.

**Function**

The "Room Green Leaf" calculates in the background the room-wide impact of manual interventions on energy efficiency. Here, all technical installations are considered, i.e. HVAC, lighting and blinds. Various inputs from the disciplines HVAC, lighting, and shading, as well as general room conditions form the basis. The determined state "poor/excellent" is indicated by the Green Leaf symbol on the room operator unit with a change in color to the Green Leaf. Pressing the Green Leaf button on the room operator unit resets all manual interventions, runtimes, or setpoint changes, there are classified as not efficient. The plant then continues to operate in the automatic, energy-efficient operating mode via its control function. The monitoring is referred to as the Green Leaf function or RoomOptiControl.

## 12.2 Room operator unit QMX3.P34



**Figure: Room operator unit QMX3.P34**

### Function

The room unit QMX3.P34 is used in rooms

- to acquire the room temperature
- to operate Comfort and HVAC functions

The room operator unit communicates with the DXR2 room automation station via the KNX PL-Link bus.

A segmented LCD display displays the HVAC states in the room. The various state displays and associated operations on the room operator unit can be configured for enable or disable. Up to 8 capacitive operating buttons are used to operate the room. The buttons are assigned set functions.

In addition, the leaf symbol of the Green Leaf function tells the room user if the room is operated efficiently.

### Display and arrangement of the buttons

The top half of the device consists of one LCD display and capacitive buttons to operate HVAC room functions. The HVAC function selection and operation occurs on buttons 1 through 8; the Green Leaf (green/red lead) is located in the upper right-hand corner on button 5.

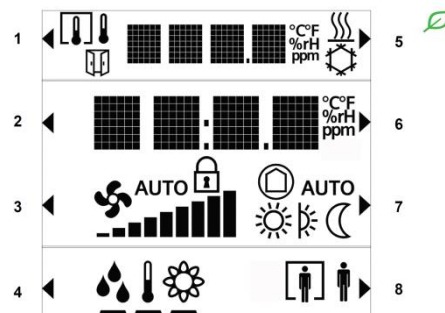

**Figure: Configurable displays on the QMX3.P34 display**

### Displays

The following displays can be configured:

- Window contact state
- Present measured room temperature or outside temperature
- Present measured room humidity (requires a separate humidity sensor in the room)
- Present measured room air quality in ppm or clear text (requires a separate air quality sensor in the room)
- State heating/cooling
- Present setpoint for room temperature relative or absolute in °C
- Present fan stage
- Present operating mode for room

- Display of present displayed data (temperature, humidity, or air quality)
- Present presence button state

**Operation**

The following operating elements can be configured to be available to the room user:

	1		5	Green Leaf operation
Room setpoint. - Operation	2		6	Room setpoint. + Operation
Fan stage operation	3		7	
Select display	4		8	Operation of presence control or temporary Comfort extension

## 12.3 Room operator unit QMX3.P74



**Figure: Room operator unit QMX3.P74**

**Function**

The room unit QMX3.P34 is used in rooms

- to acquire the room temperature
- to acquire room temperature
- to acquire the room air quality
- to operate Comfort and HVAC functions

The room operator unit communicates with the DXR2 room automation station via the KNX PL-Link bus.

A segmented LCD display displays the HVAC states in the room. The various state displays and associated operations on the room operator unit can be configured for enable or disable. Up to 8 capacitive operating buttons are used to operate the room. The buttons are assigned set functions.

In addition, the leaf symbol of the Green Leaf function tells the room user if the room is operated efficiently.

**Display and arrangement of the buttons**

The top half of the device consists of one LCD display and capacitive buttons to operate HVAC room functions. The HVAC function selection and operation occurs on buttons 1 through 8; the Green Leaf (green/red lead) is located in the upper right-hand corner on button 5.

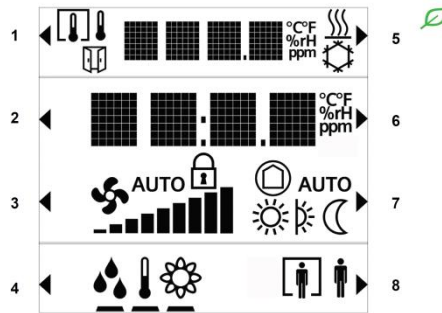

**Figure: Configurable displays on the QMX3.P74 display**

**Displays**

The following displays can be configured:

- Window contact state
- Present measured room temperature or outside temperature
- Present measured room humidity
- Present measured room air quality in ppm or clear text
- State heating/cooling
- Present setpoint for room temperature relative or absolute in °C
- Present fan stage
- Present operating mode for room
- Display of present displayed data (temperature, humidity, or air quality)
- Present presence button state

**Operation**

The following operating elements can be configured to be available to the room user:

		Green Leaf operation
Room setpoint. - Operation		Room setpoint. + Operation
Fan stage operation		
Select display		Operation of presence control or temporary Comfort extension

## 12.4 Room operator unit QMX3.P36



**Figure: Room operator unit QMX3.P36**

### Function

The room unit QMX3.P36 is used in the rooms

- to acquire the room temperature
- to operate Comfort and HVAC functions

The room operator unit communicates with the DXR2 room automation station via the KNX PL-Link bus.

HVAC states are displayed on one LCD display on a page. Various layouts can be selected on the Desigo room automation system for the QMX3.P36. The layouts cannot be modified. Up to 8 capacitive operating buttons are used to operate the room. The buttons are assigned set functions.

In addition, the leaf symbol of the Green Leaf function tells the room user if the room is operated efficiently.

### Display and arrangement of the buttons

The QMX3.P36 room operator unit consists of one LCD display and capacitive buttons to operate HVAC room functions. The HVAC function selection occurs on buttons 1 through 8; the Green Leaf (green/red lead) is located in the upper right-hand corner on button 5.

### 12.4.1 Layouts for fan coil applications

The following layouts are available in the configurable Desigo room automation station for fan coil applications.

	<ul style="list-style-type: none"> <li>• Display of heating/cooling state</li> <li>• Display and operation of the present setpoint for room temperature, absolute in °C</li> <li>• Display and operation of present fan stage</li> <li>• Display and operation of present presence control</li> </ul>
	<ul style="list-style-type: none"> <li>• Display of heating/cooling state</li> <li>• Display and operation of the present setpoint for room temperature, relative in K or °C</li> <li>• Display and operation of present fan stage</li> <li>• Display and operation of present presence control</li> </ul>

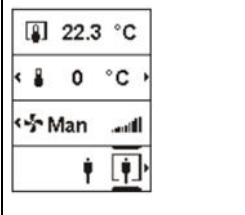
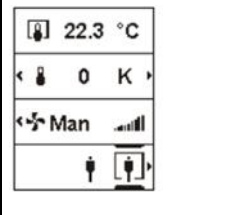
		<ul style="list-style-type: none"> <li>• Display of present measured room temperature</li> <li>• Display and operation of the present setpoint for room temperature, relative in K or °C</li> <li>• Display and operation of present fan stage</li> <li>• Display and operation of present presence control</li> </ul>
---	---	--

## 12.4.2 Layouts for radiators and ceiling heating/chilled ceiling applications

The following layouts are available in the configurable Desigo room automation station for radiators and ceiling heating/chilled ceiling applications.

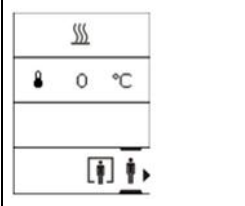
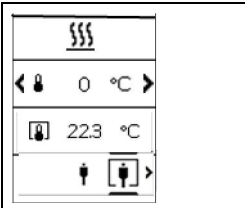
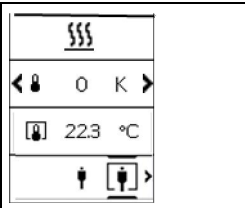
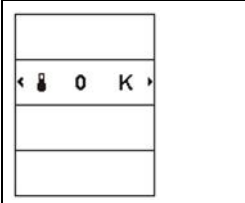
		<ul style="list-style-type: none"> <li>• Display of heating/cooling state</li> <li>• Display and operation of the present setpoint for room temperature, absolute in °C</li> <li>• Display and operation of present presence control</li> </ul>
		<ul style="list-style-type: none"> <li>• Display of heating/cooling state</li> <li>• Display and operation of the present setpoint for room temperature, relative in K or °C</li> <li>• Present measured room temperature</li> <li>• Display and operation of present presence control</li> </ul>
		<ul style="list-style-type: none"> <li>• Display and operation of the present setpoint for room temperature, relative in K</li> </ul>



### 12.4.3 Layouts for VAV applications

The following layouts are available in the configurable Desigo room automation station for VAV applications.

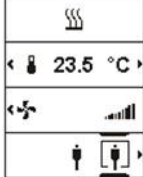
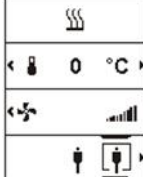
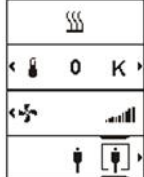
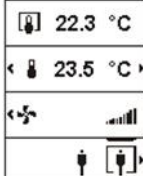
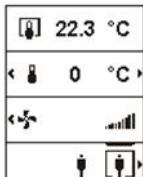
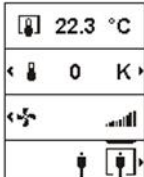
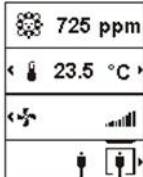
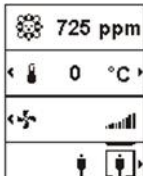
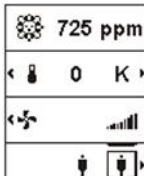
	<ul style="list-style-type: none"> <li>• Display of heating/cooling state</li> <li>• Display and operation of the present setpoint for room temperature, absolute in °C</li> <li>• Display and operation of boost ventilation</li> <li>• Display and operation of present presence control</li> </ul>	
		<ul style="list-style-type: none"> <li>• Display of heating/cooling state</li> <li>• Display and operation of the present setpoint for room temperature, relative in K or °C</li> <li>• Display and operation of boost ventilation</li> <li>• Display and operation of present presence control</li> </ul>
	<ul style="list-style-type: none"> <li>• Present measured room temperature</li> <li>• Display and operation of the present setpoint for room temperature, absolute in °C</li> <li>• Display and operation of boost ventilation</li> <li>• Display and operation of present presence control</li> </ul>	
		<ul style="list-style-type: none"> <li>• Present measured room temperature</li> <li>• Display and operation of the present setpoint for room temperature, relative in K or °C</li> <li>• Display and operation of boost ventilation</li> <li>• Display and operation of present presence control</li> </ul>
	<ul style="list-style-type: none"> <li>• Present measured air quality in ppm</li> <li>• Display and operation of the present setpoint for room temperature, absolute in °C</li> <li>• Display and operation of boost ventilation</li> <li>• Display and operation of present presence control</li> </ul>	
		<ul style="list-style-type: none"> <li>• Present measured air quality in ppm</li> <li>• Display and operation of the present setpoint for room temperature, relative in K or °C</li> <li>• Display and operation of boost ventilation</li> <li>• Display and operation of present presence control</li> </ul>

## 12.5 Room operator unit QMX3.P37



Figure: Room operator unit QMX3.P37

### Function

The room unit QMX3.P37 is used in rooms

- to acquire the room temperature
- to operate Comfort and HVAC functions
- to operate lighting and blinds applications

The room operator unit communicates with the DXR2 room automation station via the KNX PL-Link bus.

A segmented LCD display displays the HVAC states in the room. The various state displays and associated operations on the room operator unit can be configured for enable or disable. Up to 8 capacitive operating buttons are used to operate the room. The buttons are assigned set functions.

In addition, the leaf symbol of the Green Leaf function tells the room user if the room is operated efficiently.

### 12.5.1 HVAC operator panel (upper half)

The top half of the device consists of one LCD display and capacitive buttons to operate HVAC room functions. The HVAC function selection occurs on buttons 1 through 8; the Green Leaf (green/red lead) is located in the upper right-hand corner on button 5.

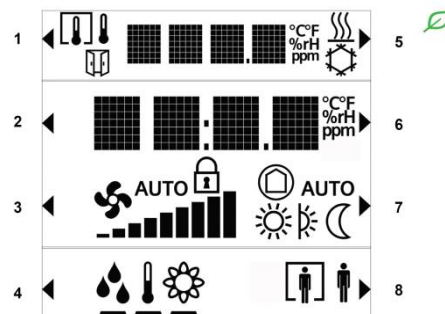

Figure: Configurable displays on the QMX3.P37 display

### Displays

The following displays can be configured:

- Window contact state
- Present measured room temperature or outside temperature
- Present measured room humidity (requires a separate humidity sensor in the room)
- Present measured room air quality in ppm or clear text (requires a separate air quality sensor in the room)
- State heating/cooling

- Present setpoint for room temperature relative or absolute in °C
- Present fan stage
- Present operating mode for room
- Display of present displayed data (temperature, humidity, or air quality)
- Present room occupancy

**Operation**

The following operating elements can be configured to be available to the room user:

		Green Leaf operation
Room setpoint. - Operation		Room setpoint. + Operation
Fan stage operation		
Select display		Operation of presence control or temporary Comfort extension

### 12.5.2 Electric operator panel (lower half)

The lower half of the device consists of one window for a designation sign. Labels for the operating functions for the given capacitive buttons can be placed in this window. The 8 lower buttons operate the functions. The following electric operating fields can be selected in the configurable Desigo room automation system.

**4 x Light dimming**

	<p>The operator panel manually operate of 4 KNX PL-Link light outputs. This requires 4 horizontal button pairs.</p> <ul style="list-style-type: none"> <li>• Switch off + Dim lighting</li> <li>• Switch on + Make lighting brighter</li> </ul>
--	---

**2 x Light dimming  
2 x blinds**

	<p>This operator panel manually operates 2 KNX PL-Link light outputs and 2 KNX PL-Link blinds outputs.</p> <p>This requires 4 horizontal button pairs.</p> <ul style="list-style-type: none"> <li>• Switch off + Dim lighting</li> <li>• Switch on + Make lighting brighter</li> <li>• Blinds down</li> <li>• Blinds up</li> </ul>
--	--

**4 x Light switching  
2 x blinds**

	<p>This operator panel manually operates 4 KNX PL-Link light outputs and 2 KNX PL-Link blinds outputs.</p> <p>Requires 4 individual buttons and 2 horizontal button pairs.</p> <ul style="list-style-type: none"> <li>• Switch on/off lighting</li> <li>• Blinds down</li> <li>• Blinds up</li> </ul>
--	---

**Templates for labeling**

The electrical operator panel uses labels. The labels are inserted from below into the window for the electric operator panel on the QMX3.P37. A template is available to create labels at [www.siemens.com/download?A6V10424435](http://www.siemens.com/download?A6V10424435)

## 12.6 Room operator unit QMX3.P02



Figure: Room operator unit QMX3.P02

### Function

The room unit QMX3.P02 is used in rooms

- to acquire the room temperature
- to operate lighting and blinds applications

The room operator unit communicates with the DXR2 room automation station via the KNX PL-Link bus.

### 12.6.1 Electric operator panel (lower half)

The lower half of the device consists of one window for a designation sign. Labels for the operating functions for the given capacitive buttons can be placed in this window. The 8 lower buttons operate the functions. The following electric operating fields can be selected in the configurable Designo room automation system.









#### 4 x Light dimming

		<p>The operator panel manually operate of 4 KNX PL-Link light outputs. This requires 4 horizontal button pairs.</p> <ul style="list-style-type: none"> <li>• Switch off + Dim lighting</li> <li>• Switch on + Make lighting brighter</li> </ul>

#### 2 x Light dimming 2 x blinds

		<p>This operator panel manually operates 2 KNX PL-Link light outputs and 2 KNX PL-Link blinds outputs. This requires 4 horizontal button pairs.</p> <ul style="list-style-type: none"> <li>• Switch off + Dim lighting</li> <li>• Switch on + Make lighting brighter</li> <li>• Blinds down</li> <li>• Blinds up</li> </ul>

**4 x Light switching  
2 x blinds**

		<p>This operator panel manually operates 4 KNX PL-Link light outputs and 2 KNX PL-Link blinds outputs.</p>
		<p>Requires 4 individual buttons and 2 horizontal button pairs.</p>
		<ul style="list-style-type: none"> <li>• Switch on/off lighting</li> <li>• Blinds down</li> <li>• Blinds up</li> </ul>
		

**Templates for labeling**

The electrical operator panel uses labels. The labels are inserted from below into the window for the electric operator panel on the QMX3.P02. A template is available to create labels at [www.siemens.com/download?A6V10424435](http://www.siemens.com/download?A6V10424435)

## 13 Room coordination functions

Comprehensive, configurable applications for room automation are included in the delivery for Desigo. Desigo room automation is based on proven application functions per VDI 3813 as well as energy efficiency class A per DIN EN 15232.

### Application functions

Room climate	<ul style="list-style-type: none"> <li>• Temperature control (heating, cooling) with radiators, chilled ceilings, fan coils, VAV systems</li> <li>• Air quality control with VAV systems</li> <li>• Room operating modes (Comfort, Pre-Comfort, Economy, Protection)</li> <li>• Start/stop optimization or boost heating</li> <li>• Night cooling, downdraft compensation</li> <li>• Etc.</li> </ul>
Lighting	<ul style="list-style-type: none"> <li>• Switching, dimming</li> <li>• Constant light control</li> <li>• Automatic lighting based on daylight switching</li> <li>• Dusk/dawn switching</li> <li>• Stairwell lighting</li> <li>• Etc.</li> </ul>
Shading	<ul style="list-style-type: none"> <li>• Anti-glare protection with automatic solar protection or slat adjustment</li> <li>• Automatic thermal function for day and night</li> <li>• Automatic dusk/dawn adjustment</li> <li>• Weather protection (rain, wind, frost)</li> <li>• Etc.</li> </ul>
Room functions	<ul style="list-style-type: none"> <li>• Room-wide operating mode determination</li> <li>• Energy optimization together with HVAC and blinds</li> <li>• Green Leaf function</li> </ul>
Central functions	<ul style="list-style-type: none"> <li>• Automatic start optimization</li> <li>• Seasonal room temperature compensation</li> <li>• Central operation and control of room operating mode and setpoints</li> <li>• Emergency controls for HVAC, light, and blinds</li> <li>• Demand-dependent hot water supply</li> <li>• Demand-dependent chilled water supply including condensation monitor using sensors</li> <li>• Control for free cooling and optimized use of existing cooling energy</li> <li>• Demand-dependent hot/chilled water supply for 2-pipe systems with changeover</li> <li>• Demand-dependent air supply for supply air and extract air for optimized ventilation operation (pressure optimized)</li> <li>• Central weather station for all application</li> </ul>

(Continued on next page)

(Cont.)

Central functions	<ul style="list-style-type: none"> <li>• Central facade control as per solar position and brightness for anti-glare protection and energy-optimized HVAC operation</li> <li>• Central protection functions (wind, frost) for the facades</li> <li>• Delayed groups to control lighting and blinds in large buildings</li> </ul>
-------------------	---

**Sensor and actor functions**

Sensor functions	<ul style="list-style-type: none"> <li>• Presence detection</li> <li>• Window monitoring</li> <li>• Dewpoint monitoring</li> <li>• Temperature measurement</li> <li>• Relative humidity measurement</li> <li>• Brightness measurement</li> <li>• Air quality measurement</li> <li>• Wind speed measurement (central)</li> <li>• Precipitation detection (central)</li> </ul>
Actor functions	<ul style="list-style-type: none"> <li>• Actuator</li> <li>• Lighting actor</li> <li>• Blinds actor</li> </ul>
Local operating /display functions	<ul style="list-style-type: none"> <li>• Set temperature setpoint</li> <li>• Select room occupancy</li> <li>• Operate fan coil</li> <li>• Green Leaf function</li> <li>• Switch/dim lighting</li> <li>• Set solar protection</li> </ul>

## 13.1 Room functions: Room coordination

The DXR2 applications guarantee the interaction of disciplines HVAC, lighting, and shading, and provide the necessary coordination functions to this end.

**Room operating mode determination**

The elementary room coordination function is the determination of the room operating mode from the central scheduler and local presence/Comfort extension entries on the room operator unit.

**Green Leaf**

Desigo TRA offers room users interaction with regard to energy management via an innovative operating and displaying concept.

The Green Leaf application function determines whether manual operations negative impact HVAC energy efficiency. A red leaf on the room operator unit informs the room occupant of just such a situation. The leaf returns to green by activating the red leaf as the Green Leaf returns the room to an energy efficient state. A room operator unit with Green Leaf display is required to use the Green Leaf application function.

Each discipline has its own rules for determining the influence of energy efficiency that is evaluated in the room coordination function.

The criteria for evaluating energy efficiency are:

- The maximum tolerance to manually shift the room temperature setpoint can be configured.

Description	Name	Default value
Maximum tolerance of room temperature setpoint shift	TolMaxSpTRShft	2 [K]

- Fan speed: No configuration. A higher value than the automatic value is classified as inefficient.
- Room operating mode: No configuration. A higher value than the automatic value is classified as inefficient.
- Lighting: No configuration. Lighting setpoints cannot be less energy efficient than the automatic values.
- Shading: No configuration. Shading positions cannot be less energy efficient than the automatic values.

### Thermal room load analysis

The application tracks the heating/cooling state of the room as well as average room temperature over 24 hours and notes the Comfort room temperature setpoints for heating and cooling. And decides, based on the present comfort setpoints for cooling and heating, the room temperature and heating/cooling state whether shading supports heating and cooling. The information is provided to the local shading elements in the room and processed as per the settings.

The application outputs the thermal room load condition with two states: Load (heating) and discharge (cooling).

### Dedicated lock/enable of Comfort/HVAC operations

Manual operation on all room operator units for HVAC can be locked based on the specified central operating mode. Manual operation for lighting and blinds is always available and is not impacted by this function.

A parameter determines if manual operation can be locked for HVAC. Manual HVAC operation is locked during the displayed room operating modes, i.e. Comfort cannot be increased and energy efficiency cannot be changed.

Description	Name	Default value
Configuration lock manual operation 1:None 2: Protection 3:Protection / Economy 4: Protection/Economy to Pre-Comfort	ManOpLockCnf	3:Protection / Economy



## Room control by switching the operating mode

### Trigger signals indicate switch to energy efficiency or Comfort

The room operating mode can automatically control the various applications for HVAC, lighting, or shading. Two trigger signals are available in each room. They are sent to all disciplines on a configured change to room operating mode occurs. The two triggers are "Energy efficiency condition" and "Comfort condition".

You can determine which trigger to send to the disciplines for each change in operating mode.

Description	Name	Default value
Comfort/Pre-Comfort/Economy to Protection 1:None 2:Energy efficiency condition 3:Comfort condition	CmfPcfEcoToPrt	2:Energy efficiency condition
Comfort/Pre-Comfort to Economy Enumeration see CmfPcfEcoToPrt	CmfPcfToEco	2:Energy efficiency condition
Comfort to Pre-Comfort Enumeration see CmfPcfEcoToPrt	CmfToPcf	2:Energy efficiency condition
Protection/Economy/Pre-Comfort to Comfort Enumeration see CmfPcfEcoToPrt	PrtEcoPcfToCmf	3:Comfort condition
Protection/Economy to Pre-Comfort Enumeration see CmfPcfEcoToPrt	PrtEcoToPcf	1:None
Protection to Economy Enumeration see CmfPcfEcoToPrt	PrtToEco	1:None

### Repeat trigger

The "Energy efficiency condition" trigger can be repeated automatically. The number of repeats to the disciplines as well as the time between repetitions can be configured.

Description	Name	Default value
Repeat time energy efficiency trigger; A repeat of the trigger overrides local, manual commands. The parameter affects only the automatic trigger	RptTiEefTrg	60 min
Number of repetitions energy efficiency trigger; The parameter affects only the automatic trigger	RptNumEefTrg	0

**Example**

Reactions to the trigger can be configured for the specific discipline. The following table provides an overview on a possible configuration.

Description	Name	Default value
Presence button Eco → Cmf	CmfCndTrg 3:Manual	HVAC: No impact
		Lighting: On/start constant lighting control
		Shading: Stop automatic function
Presence button Cmf → Eco	EefCndTrg 3:Manual	HVAC: Reset setpoint offset
		Lighting: Immediate off/stops constant lighting control
		Shading: Enable or manual operation and transition to automatic position.
Central scheduler Cmf → Eco	EefCndTrg 2:Automatic	HVAC: Reset setpoint offset
		Lighting: Off with prior flashing/stops constant lighting control
		Shading: Enable or manual operation and transition to automatic position.

## Impact of the trigger on HVAC

A manually adjusted setpoint for HVAC applications can be reset using the trigger for "Energy efficiency condition". Control is reset to automatic. The trigger acts on both the temperature setpoint as well as the setpoint for the fan stage.

The application can also recognize whether the change to the room operating mode from an automatic function or was the result of a manual operation. It can be considered during configuration.

Description	Name	Default value
Fan command for the energy efficiency condition trigger on automatic 1:None. The manual fan stage is maintained. 2:Automatic. The manual fan stage is reset.	FanCmdEefAuto	2:Automatic
Fan command for the energy efficiency condition trigger on manual	FanCmdEefMan	2:Automatic
Operating command for the energy efficiency condition trigger on automatic 1:None. The manual temperature setpoint is maintained. 2:Automatic. The manual temperature setpoint is reset.	OpCmdEefAuto	2:Automatic
Operating command for the energy efficiency condition trigger on manual	OpCmdEefMan	1:None

For HVAC applications, rapid ventilation can be activated using the "Energy efficiency condition" and "Comfort condition" trigger. This supplies a room with rapid ventilation with fresh air for a configurable period.

The application can also recognize whether the change to the room operating mode from an automatic function or was the result of a manual operation. It can be considered during configuration.

Description	Name	Default value
Runtime rapid ventilation	TiRnRpdVnt	60 min
Operating command for the energy efficiency condition trigger on automatic 1:None. No reaction to trigger 2:Rapid ventilation. Rapid ventilation is enabled.	OpCmdEefAuto	1:None
Operating command for the energy efficiency condition trigger on manual	OpCmdEefMan	1:None
Operating command for the Comfort condition trigger on automatic	OpCmdCmfAuto	1:None
Operating command for the Comfort efficiency condition trigger on manual	OpCmdCmfMan	1:None

**Impact of the trigger on Light**

For lighting applications, lighting can be switched on, off, or reset to automatic using the triggers "Energy efficiency condition" and "Comfort condition".

The application can also recognize whether the change to the room operating mode from an automatic function or was the result of a manual operation. It can also be considered during configuration.

Description	Name	Default value
Operating command for the energy efficiency condition trigger on automatic 1:None 2:Automatic 3:Lighting on 4:Lighting off 5:Lighting off/warning (reset) 5:Lighting off/warning (permanent)	OpCmdEefAuto	1:None
Operating command for the energy efficiency condition trigger on manual	OpCmdEefMan	1:None
Operating command for the Comfort condition trigger on automatic	OpCmdCmfAuto	1:None
Operating command for the Comfort efficiency condition trigger on manual	OpCmdCmfMan	1:None

**Impact of the trigger on blinds**

For blinds applications, blinds can be held or reset to automatic using the triggers "Energy efficiency condition" and "Comfort condition".

The application can also recognize whether the change to the room operating mode from an automatic function or was the result of a manual operation. It can also be considered during configuration.

Description	Name	Default value
Operating command for the energy efficiency condition trigger on automatic 1:None. No reaction to trigger. 2:Automatic. Blinds are automatically reset to automatic. It is used to deactivate any manual operation of blinds, if the room is no longer occupied. 3:Hold. The blinds remains in the actual position and are reset to manual. This prevents unintended movement of blinds by the automatic functions when the room is occupied.	OpCmdEefAuto	2:Automatic
Operating command for the energy efficiency condition trigger on manual	OpCmdEefMan	2:Automatic
Operating command for the Comfort condition trigger on automatic	OpCmdCmfAuto	1:None
Operating command for the Comfort efficiency condition trigger on manual	OpCmdCmfMan	1:None

# 14 Radiator application

## 14.1 Hot water radiator application

All DXR2 application types include a hot water radiator application. As a rule, each DXR2 can control 2 hot water radiators via Triac or analog outputs. Hot water radiators, the controller operating mode modulating or 2-point can be configured.

### Plant diagram

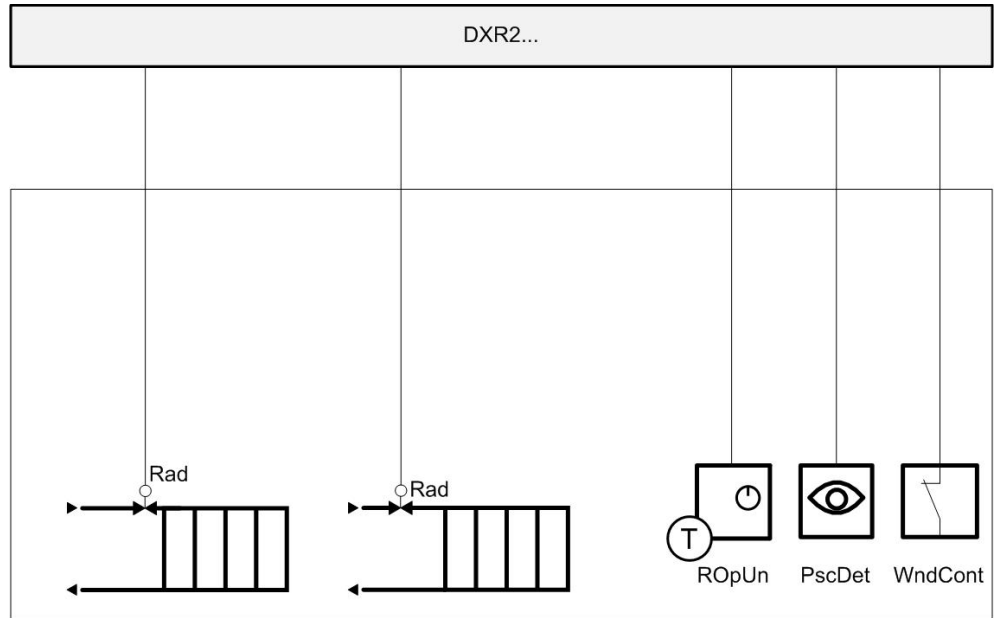

Figure: Example of radiator application

Key:

DXR2...	Room automation station	R1	Room operator unit
Rad	Radiator	D1	Presence
		D2	Window contact

### Sequences

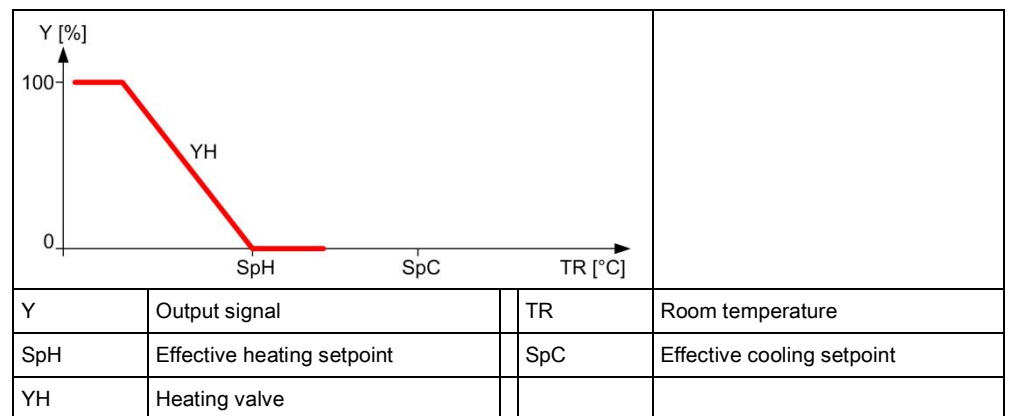

Figure: Modulating heating sequence

**Actuators**

The DRX2 automation station controls radiator valves via Triac or analog outputs, regardless of available I/Os. 3-position actuators, thermal pulse width modulation (PWM) actuators, PWM actuators with return spring can be connected to the Triac outputs.

A maximum of 1 thermal valve can be connected to each Triac on the DXR2 automation station with AC 230 V power.

**Valve protection**

Valve actuators are operated from time to time to prevent them from seizing after long periods of inactivity (e.g. heating valve during the summer). The valve actuator is controlled to lose as little heating energy as possible.

The central function for the hot water supply chain performs the valve protection function and can be changed in the parameters as needed.

Description	Name	Default value
Kick value	KickVal	50%
Kick time	TiKick	2 min
Kick cycle	KickCyc	500 h

**Downdraft compensation**

The downdraft compensation functions slows down sinking cold air current at large window surfaces and prevents in this manner a cold wall effect on large, cold surfaces. The function activates the radiator if the outside temperature drops below a configured value by increasing the minimum radiator control to a higher value. A linear reset function implements the downdraft compensation. The control sequence is only active in the Comfort room operating mode. The following graphic provides the factory settings for the downdraft compensation parameters.

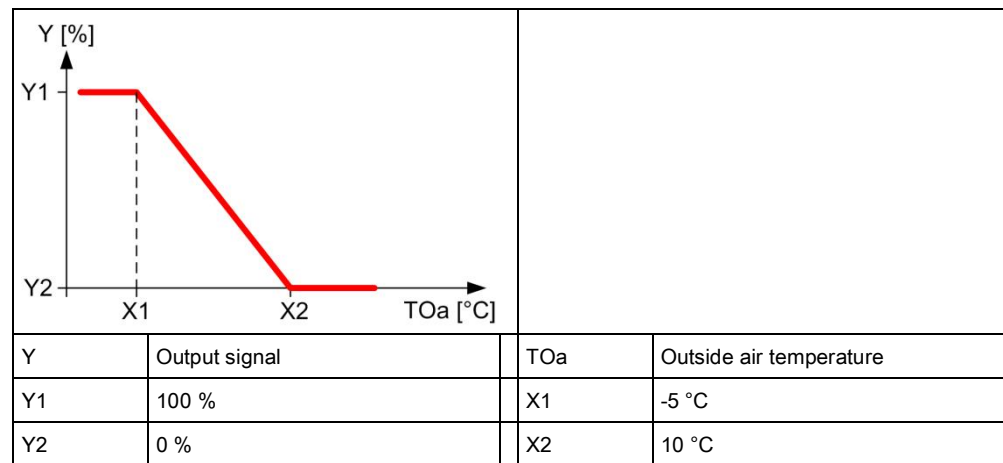

**Figure: Downdraft compensation characteristic curve**

## 14.2 Electric radiator application

All DXR2 application types include an electric radiator application. As a rule, each DXR2 can control 2 electric radiators via Triac or analog outputs. For electric hot water radiators, the controller operating mode modulating or 2-point can be configured.

### Plant diagram

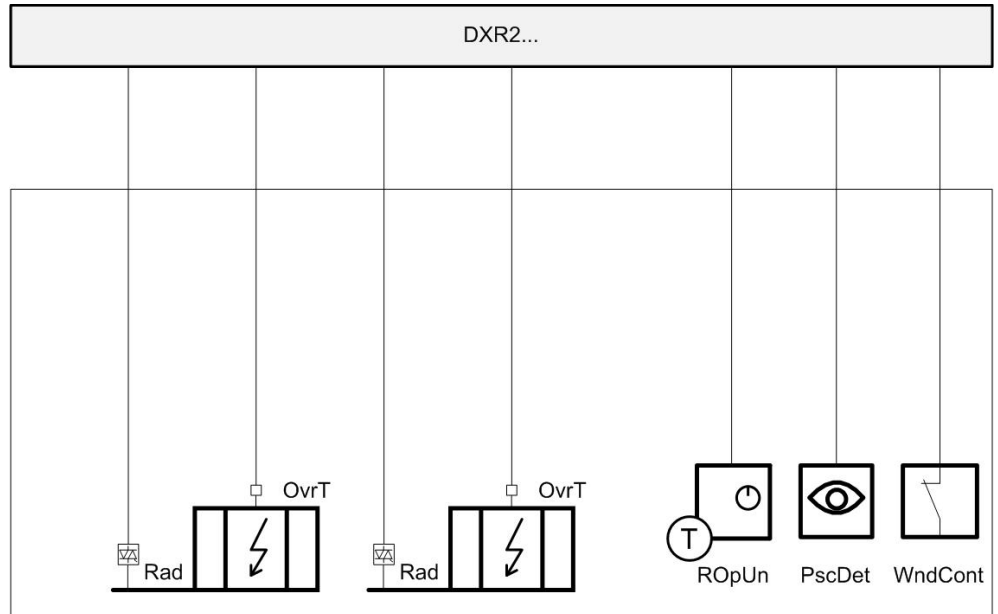

Figure: Example of radiator application

Key:

DXR2...	Room automation station	R1	Room operator unit
Rad	Radiator	D1	Presence
OvrT	Overtemperature protection	D2	Window contact

### Sequences

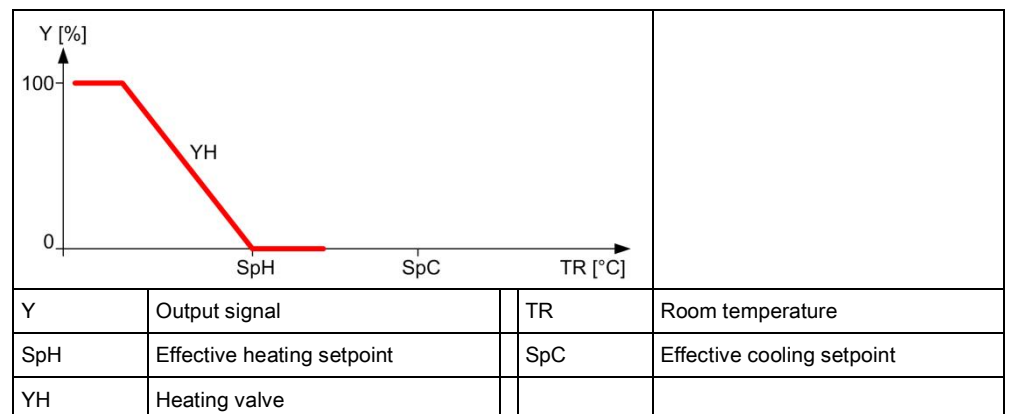

Figure: Modulating heating sequence

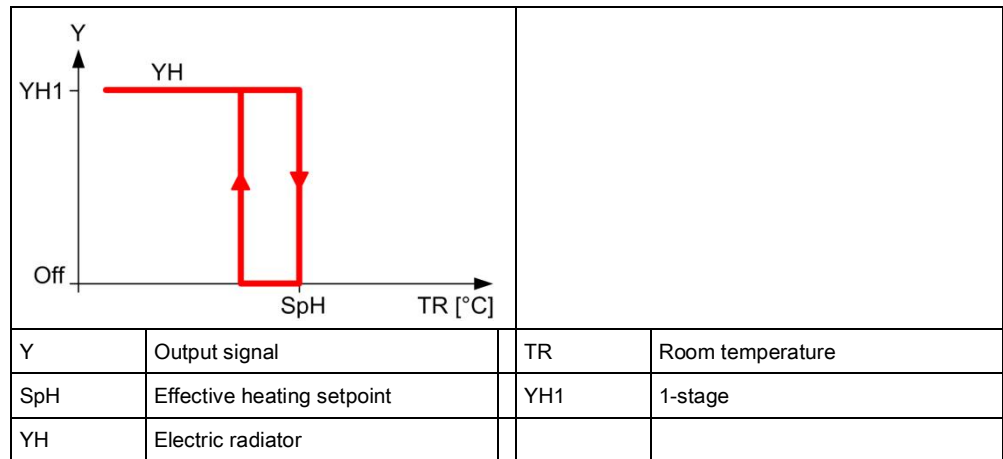

Figure: Example of radiator application

**Actuators**

The DRX2 automation station controls electric radiator valves via Triac or analog outputs, regardless of available I/Os. Single-stage and modulating electric radiators are supported. Electric radiators, controlled via an analog output on the DXR2, can receive an enable via a relay or Triac on the DXR2.

**Safety thermostat**

A binary overtemperature (open contact) protection can be connected on the DXR2 for all versions of the electric radiator application. The application switches off the radiator at device protection priority if overtemperature protection is enabled.

Description	Name	Default value
Enable overtemperature input 0:No 1:Yes	EnOvrTDetIn	0:No

**Downdraft compensation**

The downdraft compensation functions slows down sinking cold air current at large window surfaces and prevents in this manner a cold wall effect on large, cold surfaces. The function activates the radiator if the outside temperature drops below a configured value by increasing the minimum radiator control to a higher value. A linear reset function implements the downdraft compensation. The control sequence is only active in the Comfort room operating mode. The following graphic provides the factory settings for the downdraft compensation parameters.

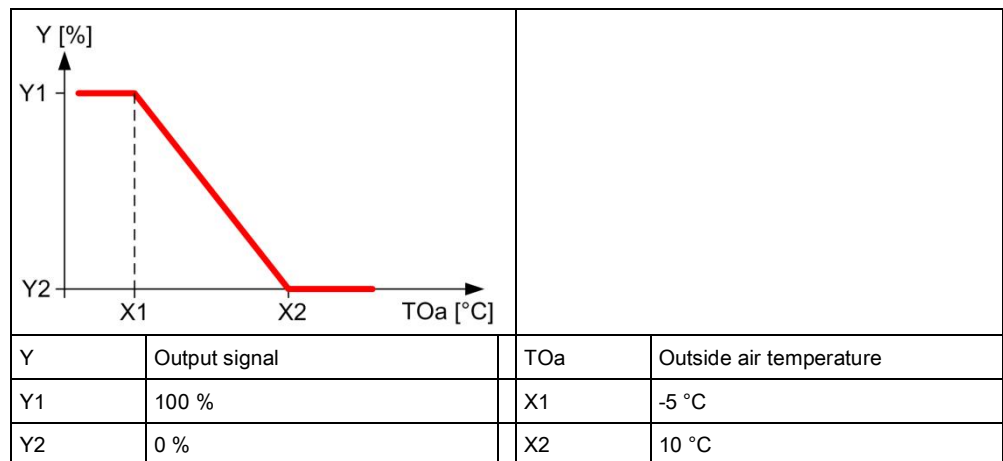

Figure: Downdraft compensation characteristic curve



### 14.3 Determination of heating/cooling state

All DXR2 applications analyze heating/cooling state by comparing the present room temperature against the setpoints and active control sequence. The present state is displayed on the room operator unit and the BAC system.

A sequence controller prevent simultaneous heating/cooling.

### 14.4 Heating/cooling demand

Each DXR2 automation station calculates heating and cooling demand for a room and makes the result available through a group of the central function (supply chain hot water/chilled water).

#### Outside air temperature dependent heating curve

The hot water demand setpoint is calculated in the central function using a heating curve based on the outside temperature.

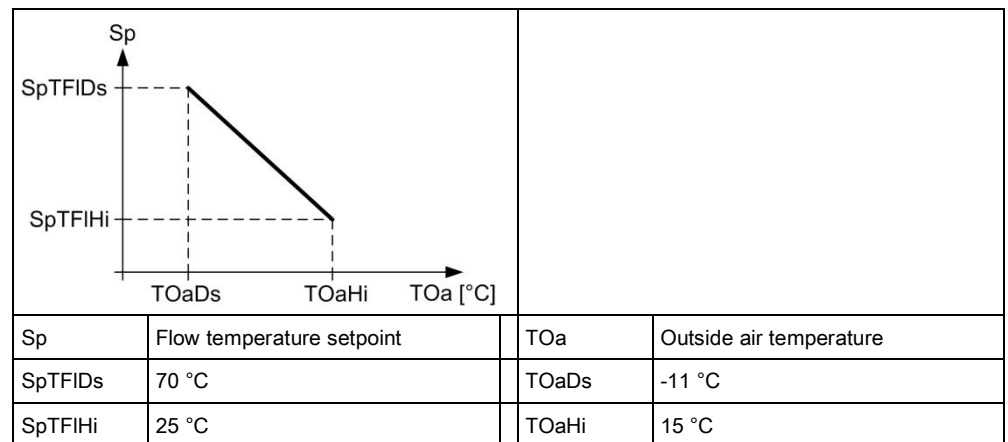

Figure: Characteristic curve for the outside temperature-dependent heating curve

#### Demand correction by collected valve positions

Valve positions in the various rooms correct the demand setpoint in the central function based on the number of valves between a value of 70...100%.

Description	Name	Default value
Setpoint correction, if 100% of all consumers are within 70...100%.	SpCorrTFIHi	5 [K]
Setpoint correction, if 0% of all consumers are within 70...100%.	SpCorrTFILo	-5 [K]

### 14.5 Preheating

The central functions can trigger the preheating function to heat up a room at end of the night setback period as quickly as possible to the Pre-Comfort setpoint. This impacts the plant operating mode of the application.

### 14.6 Emergency operation

The setpoint for protection ensures that room temperatures do not change below or above a critical limit.

### 14.7 Reset setpoint

The central function can reset a local change to a setpoint on the room operator unit. The management station can manually reset the value or the reset can also

be automatic by a scheduler. Setpoints for room temperature, ventilator stage, and room operating mode can be reset.

## 14.8 Free inputs/outputs

Inputs and outputs can be configured as free inputs on all DXR2s. This permits the querying of unused input and output switching states or directly controlling another device over BACnet.

## 14.9 Centrally override valves

Central functions permit the central override of all valve in the supply group. The following parameters can be used.

Description	Name	Default value
Enable valve position override	EnVlvPosOvrr	0:No 1:Yes
Valve position override	VlvPosOvrr	100 [%]

## 14.10 Presence control

The HVAC application can also be controlled by presence through the use of a presence detector.

The HVAC application can be configured for each room to react to presence for each room and regardless of the room operating mode.

Description	Name	Default value
Presence operating mode for Comfort 1:None 2:Considered presence 3:Considered absence 4:Considered presence & absence	PscModCmf	4:Considered presence & absence
Presence operating mode Pre-Comfort	PscModPcf	4:Considered presence & absence
Presence operating mode for Economy	PscModEco	1:None
Present operating mode for Protection	PscModPrt	1:None

The applicable delays for the HVAC application in a room can also be configured for each room.

Description	Name	Default value
Switching delay for presence	SwiDlyPrst	5 Min
Switching delay for absence	SwiDlyAbst	5 Min

## 14.11 Application examples

These are the descriptions of HIT applications on <http://hit.sbt.siemens.com>.

Visit the Siemens Download Center [www.siemens.com/bt/download](http://www.siemens.com/bt/download) for the latest application configurations.

### 14.11.1 Radiator

RAD011	Hot water radiator on triac output	A6V10662233	<a href="#">en</a>	<a href="#">de</a>
RAD012	Hot water radiator on analog output	A6V10662231	<a href="#">en</a>	<a href="#">de</a>

## 15 Radiant/chilled ceiling application

All DXR2 application types include a ceiling heating/chilled ceiling application. As a rule, each DXR2 can control 2 ceiling heating/chilled ceilings via Triac or analog outputs. For ceiling heating/chilled ceilings, the controller operating mode modulating or 2-point can be configured.

The DXR2 application can control chilled ceilings in a 2-pipe system, ceiling heating/chilled ceilings in a 2-pipe system or ceiling heating/chilled ceilings in a 4-pipe system or ceiling heating in a 2-pipe system.

### 15.1 2-pipe chilled ceiling

Plant diagram

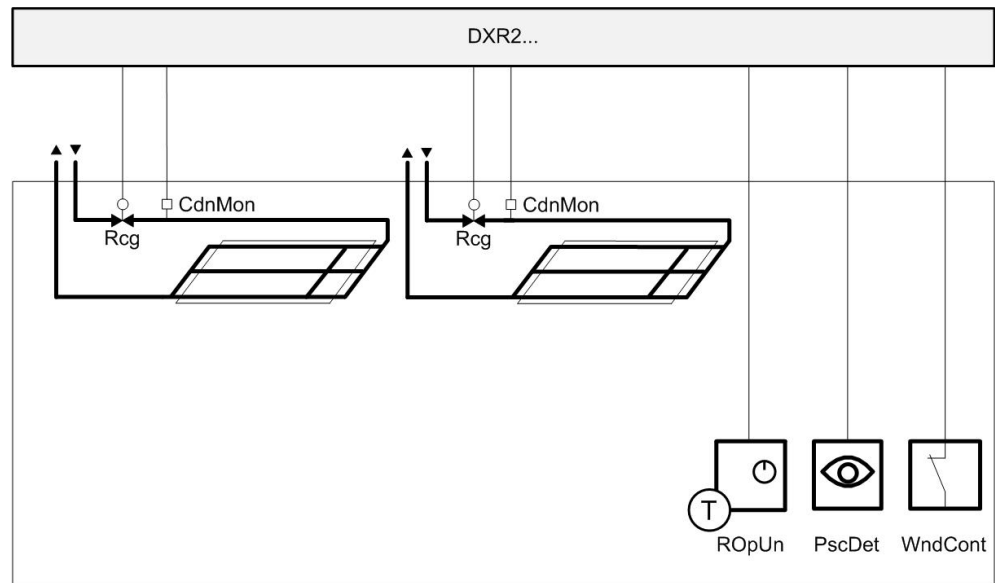

Figure: Example for a chilled ceiling application 2-pipe system

Key:

DXR2...	Room automation station	R1	Room operator unit
Rcg	Chilled ceiling valve	D1	Presence
CdnMon	Condensation monitor	D2	Window contact

Sequences

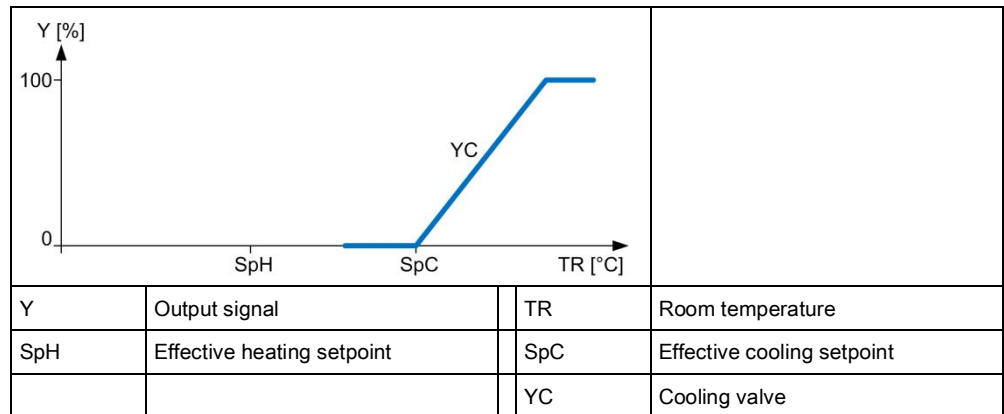

Figure: Modulating cooling sequence

## 15.2 2-pipe heated/chilled ceiling with changeover system

### Plant diagram

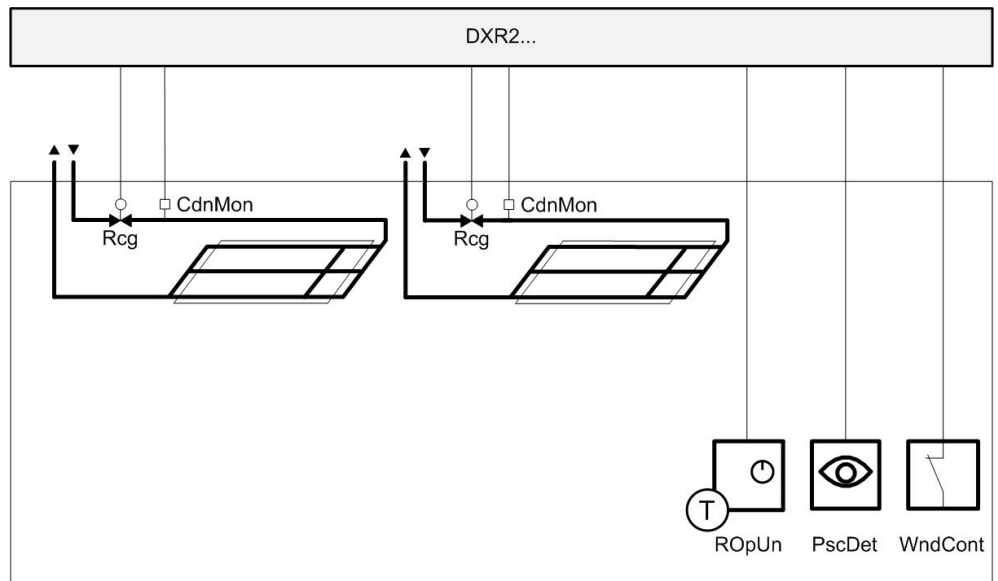

Figure: Example for a heating/chilled ceiling application 2-pipe system

Key:

DXR2...	Room automation station	R1	Room operator unit
Rcg	Heated/chilled ceiling valve	D1	Presence
CdnMon	Condensation monitor	D2	Window contact

### Sequences

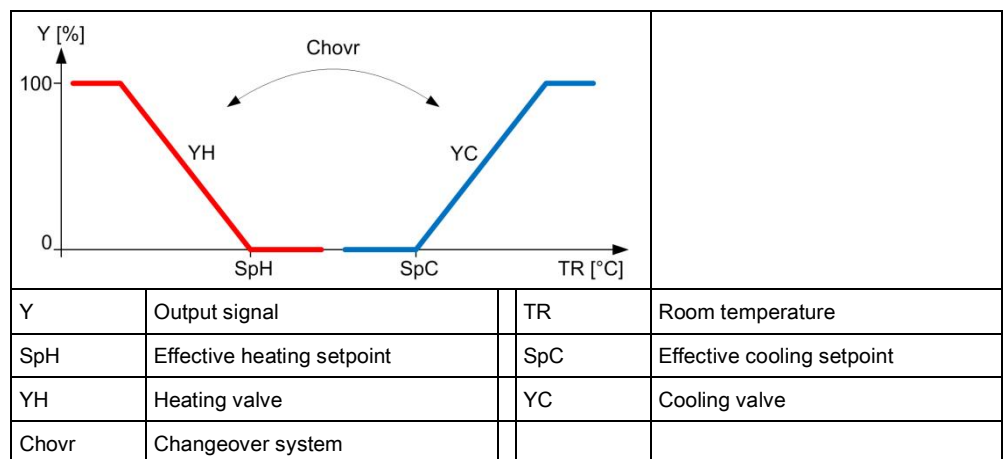

Figure: Modulating heating and cooling sequence with changeover system

### Changeover system

The central function for chilled water supply determines whether the water system is used for heating or cooling based on heating/cooling demand of individual rooms in this supply group. The evaluated result is send via grouping to the room segment to enable the heating or cooling sequence in the room.

The changeover determination logic counts each the segments with heating or cooling demand.

The cooling controller is disabled during heating and the heating controller during cooling.

### 15.3 4-pipe ceiling heating/chilled ceiling with changeover valves

Plant diagram

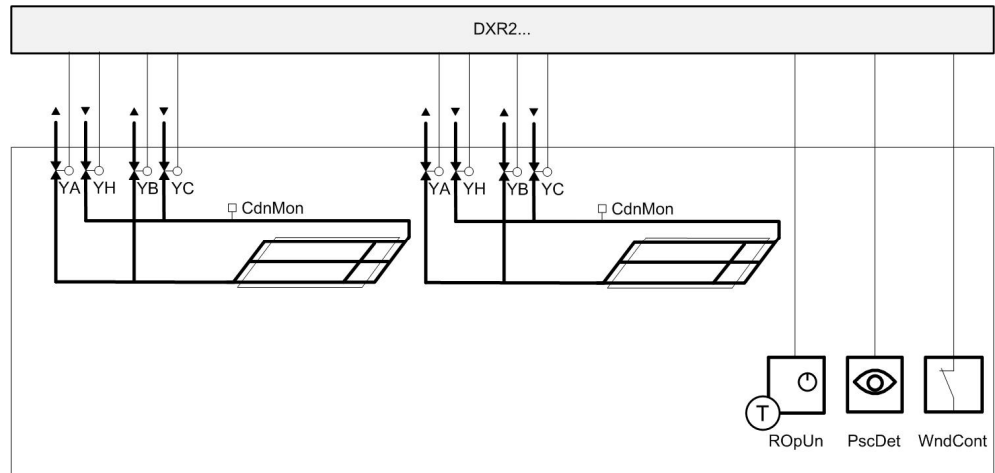

Figure: Example for heated/chilled ceiling with changeover valves

Key:

DXR2...	Room automation station	R1	Room operator unit
YH	Heating valve	D1	Presence
YA	Changeover valve heating	D2	Window contact
YC	Cooling valve	CdnMon	Condensation monitor
YB	Changeover valve cooling		

Sequences

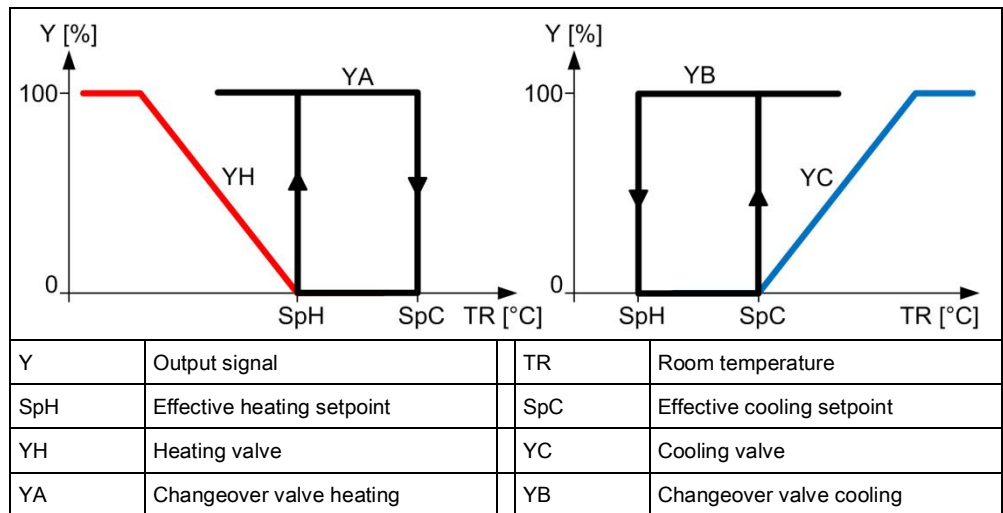

Figure: Modulating heating and cooling sequence

## 15.4 4-pipe heated/chilled ceiling with 6-port valve

Plant diagram

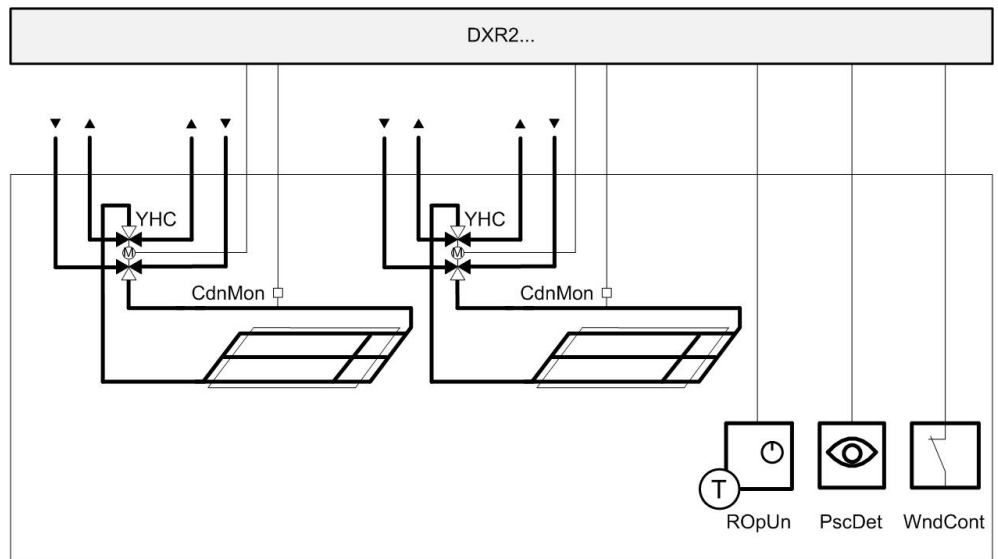

Figure: Example for a 4-pipe heated/chilled ceiling application with a 6-port valve  
Key:

DXR2...	Room automation station	R1	Room operator unit
YHC	6-port valve	D1	Presence
CdnMon	Condensation monitor	D2	Window contact

Sequences

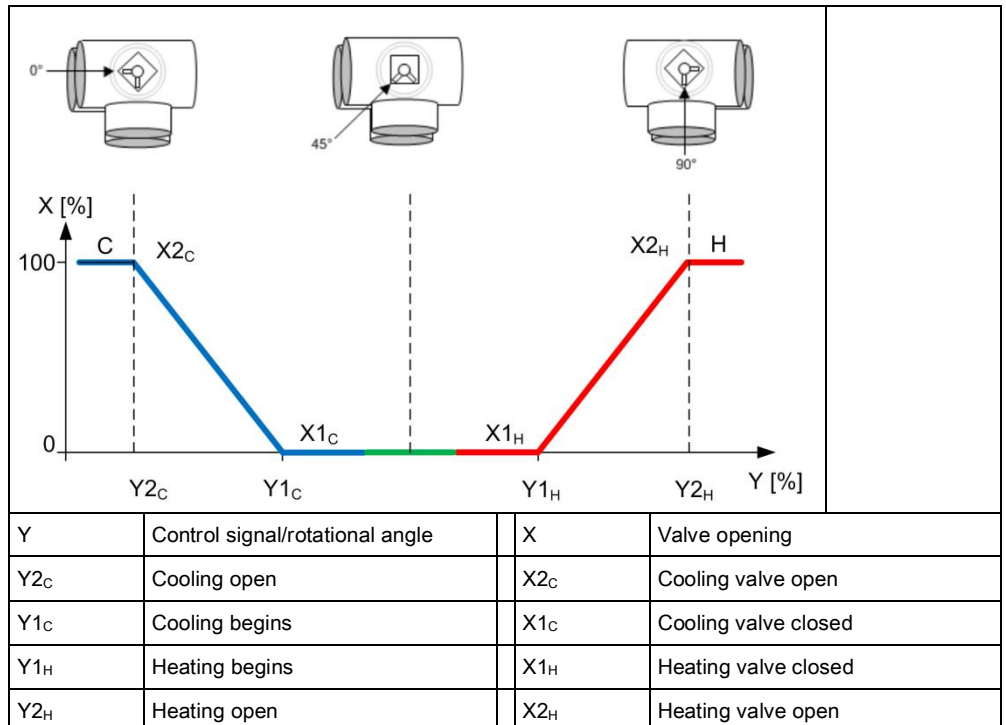

Figure: Modulating heating and cooling sequence with 6-port valve positions

Parameter settings

Description	Name	Default value
Coiling coil valve position X1C	X1CcIVlvPos	0 [%]
Coiling coil valve position Y1C	Y1CcIVlvPos	50 [%]
Coiling coil valve position X2C	X2CcIVlvPos	100 [%]
Coiling coil valve position Y2C	Y2CcIVlvPos	0 [%]
Heating coil valve position X1H	X1HcIVlvPos	0 [%]
Heating coil valve position Y1H	Y1HcIVlvPos	50 [%]
Cooling coil valve position X2H	X2HcIVlvPos	100 [%]
Heating coil valve position Y2H	Y2HcIVlvPos	100 [%]

## 15.5 2-pipe ceiling heating

Plant diagram

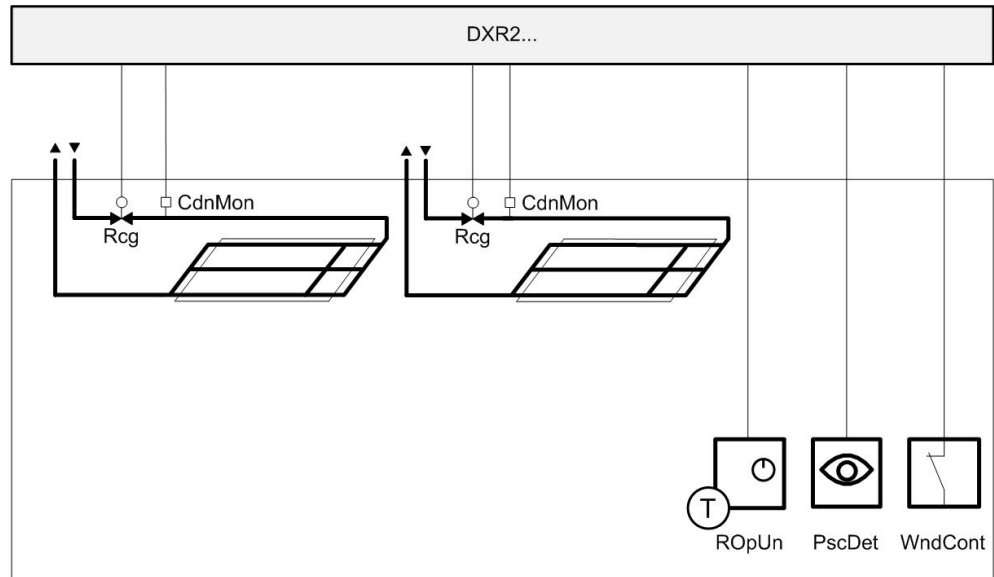

Figure: Example for a heated ceiling application 2-pipe system

Key:

DXR2...	Room automation station	R1	Room operator unit
Rcg	Heated ceiling valve	D1	Presence
CdnMon	Condensation monitor	D2	Window contact



Sequences

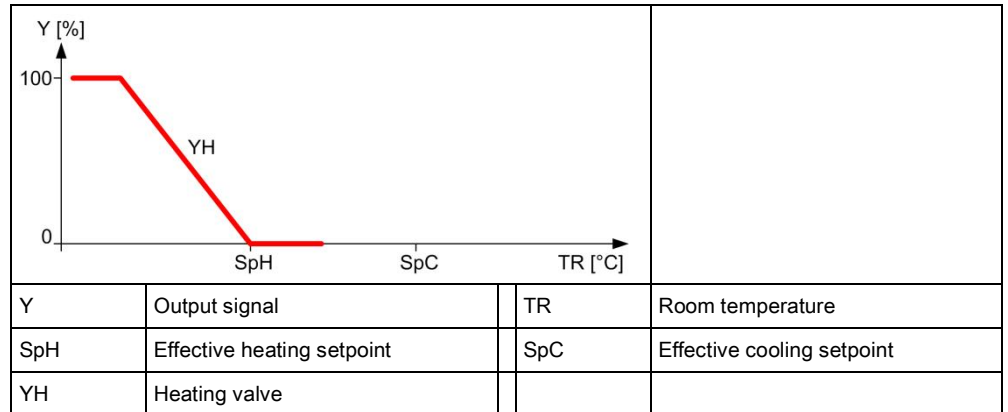

Figure: Modulating heating sequence

## 15.6 Actuators

The DRX2 automation station controls heated/chilled ceiling valves via Triac or analog outputs, regardless of available I/Os. 3-position actuators, thermal pulse width modulation (PWM) actuators, PWM actuators with return spring can be connected to the Triac outputs.

A maximum of 1 thermal valve can be connected to each Triac on the DXR2 automation station with AC 230 V power.

Conventional 0...10V actuators as well as 6-port valves can be connected to analog outputs.

## 15.7 Valve protection

Valve actuators are operated from time to time to prevent them from seizing after long periods of inactivity (e.g. heating valve during the summer). The valve actuator is controlled to lose as little heating energy as possible.

The central function for the hot water supply chain performs the valve protection function and can be changed in the parameters as needed.

Description	Name	Default value
Kick value	KickVal	50 [%]
Kick time	TiKick	2 min
Kick cycle	KickCyc	500 h

## 15.8 Determination of heating/cooling state

All DXR2 applications analyze heating/cooling state by comparing the present room temperature against the setpoints and active control sequence. The present state is displayed on the room operator unit and the BAC system.

A sequence controller prevent simultaneous heating/cooling.

## 15.9 Heating/cooling demand

Each DXR2 automation station calculates heating and cooling demand for a room and makes the result available through a group of the central function (supply chain hot water/chilled water).

**Outside air temperature dependent heating curve**

The hot water demand setpoint is calculated in the central function using a heating curve based on the outside temperature.

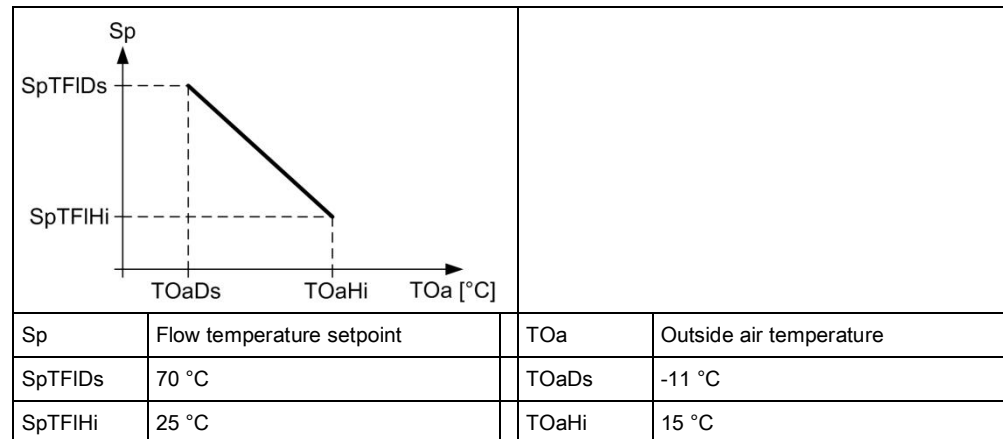

**Figure: Characteristic curve for the outside temperature-dependent heating curve**

**Demand correction by collected valve positions**

Valve positions in the various rooms correct the demand setpoint in the central function based on the number of valves between a value of 70...100%.

Description	Name	Default value
Setpoint correction, if 100% of all consumers are within 70...100%.	SpCorrTFIHi	5 [K]
Setpoint correction, if 0% of all consumers are within 70...100%.	SpCorrTFILo	-5 [K]

## 15.10 Preheating

The central functions can trigger the preheating function to heat up a room at end of the night setback period as quickly as possible to the Pre-Comfort setpoint. This impacts the plant operating mode of the application.

## 15.11 Emergency operation

The setpoint for protection ensures that room temperatures do not change below or above a critical limit.

## 15.12 Free cooling

The function free cooling to take advantage of cooling generated without effort to cool the rooms to a room temperature setpoint. Dew point compensation is still available for the chilled water temperature setpoint dependent on active dew point detector via the grouping function.

This supply chain is continued accordingly, in other words chilled water generation (chillers, refrigeration machines, etc.) are also controlled based on demand.

## 15.13 Reset setpoint

The central function can reset a local change to a setpoint on the room operator unit. The management station can manually reset the value or the reset can also be automatic by a scheduler. Setpoints for room temperature, ventilator stage, and room operating mode can be reset.

## 15.14 Free inputs/outputs

Inputs and outputs can be configured as free inputs on all DXR2s. This permits the querying of unused input and output switching states or directly controlling another device over BACnet.

## 15.15 Centrally override valves

Central functions permit the central override of all valve in the supply group. The following parameters can be used.

Description	Name	Default value
Enable valve position override	EnVlvPosOvrr	0:No 1:Yes
Valve position override	VlvPosOvrr	100 [%]

## 15.16 Presence control

The HVAC application can also be controlled by presence through the use of a presence detector.

The HVAC application can be configured for each room to react to presence for each room and regardless of the room operating mode.

Description	Name	Default value
Presence operating mode for Comfort 1:None 2:Considered presence 3:Considered absence 4:Considered presence & absence	PscModCmf	4:Considered presence & absence
Presence operating mode Pre-Comfort	PscModPcf	4:Considered presence & absence
Presence operating mode for Economy	PscModEco	1:None
Present operating mode for Protection	PscModPrt	1:None

The applicable delays for the HVAC application in a room can also be configured for each room.

Description	Name	Default value
Switching delay for presence	SwiDlyPrst	5 Min
Switching delay for absence	SwiDlyAbst	5 Min

## 15.17 Application examples

These are the descriptions of HIT applications on <http://hit.sbt.siemens.com>.

Visit the Siemens Download Center [www.siemens.com/bt/download](http://www.siemens.com/bt/download) for the latest application configurations.

### 15.17.1 Chilled/heated ceiling

CCG011	Chilled ceiling on triac output	A6V10662233	<a href="#">en</a> <a href="#">de</a>
CCG012	Chilled ceiling on analog output	A6V10662231	<a href="#">en</a> <a href="#">de</a>
CCG021	Chilled ceiling with hot water radiator on triac output	A6V10662233	<a href="#">en</a> <a href="#">de</a>
CCG022	Chilled ceiling with hot water radiator on analog output	A6V10662231	<a href="#">en</a> <a href="#">de</a>
CCG061	Chilled/heated ceiling (2 pipe) with changeover on triac output	A6V10662233	<a href="#">en</a> <a href="#">de</a>
CCG062	Chilled/heated ceiling (2 pipe) with changeover on analog output	A6V10662231	<a href="#">en</a> <a href="#">de</a>
CCG081	Chilled/heated ceiling (4 pipe) with 6-way valve on analog output	A6V10662231	<a href="#">en</a> <a href="#">de</a>
INT061	Chilled ceiling with hot water radiator on triac output including lighting and blinds operation	A6V10662233	<a href="#">en</a> <a href="#">de</a>

## 16 Fan coil application

The fan coil application can be configured with a fan coil application type. Each fan coil application type can also combine a heated/chilled ceiling or radiator application. The image below provides an overview of the fan coil application type with all possible HVAC components that can be configured for a fan coil application. The configuration enabled the applicable (required) aggregate on the DXR2.

### Plant diagram

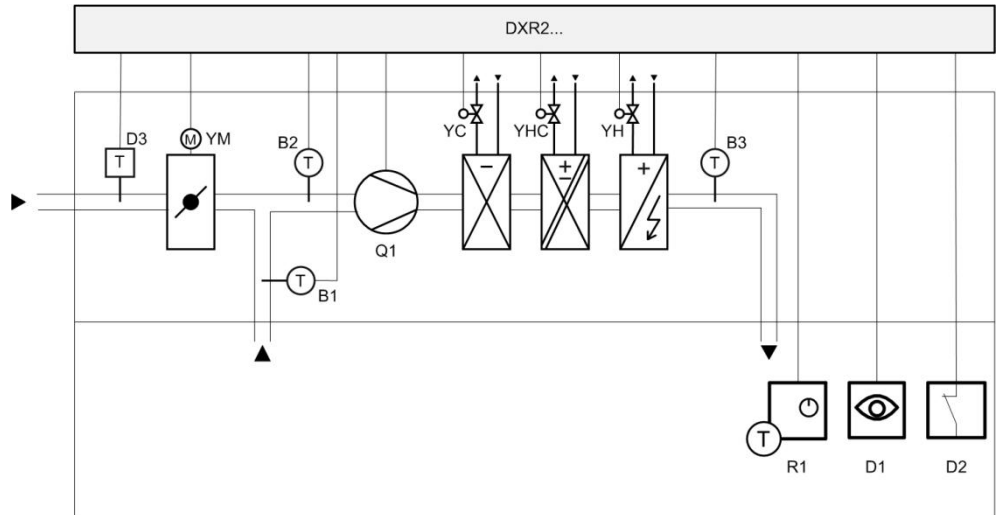

Figure: Application types for fan coil applications

Key:

DXR2...	Room automation station	R1	Room operator unit
B1	Return air temperature sensor	D1	Presence
B2	Mixed air sensor	D2	Window contact
B3	Supply air sensor	Q1	Fan
YC	Chilled water cooling coils	YHC	Heating/cooling coils
		YH	Hot water heating coils or electric heating coils

### 16.1 Serial or parallel control strategy

You must select one of 2 different control strategies on all fan coil applications:

- Serial fan operation: The air volume is only increased if the valve's or reheater's positioning signal is fully open and the room temperature exceeds or breaches an additional offset.
- Parallel fan operation: The fan speed is increased in parallel to the valve's or repeater's positioning signal.

The two strategies are illustrated in the following example using a modulating fan and one heating and cooling valve. Both strategies can be used in the same manner for staged fans.

Serial

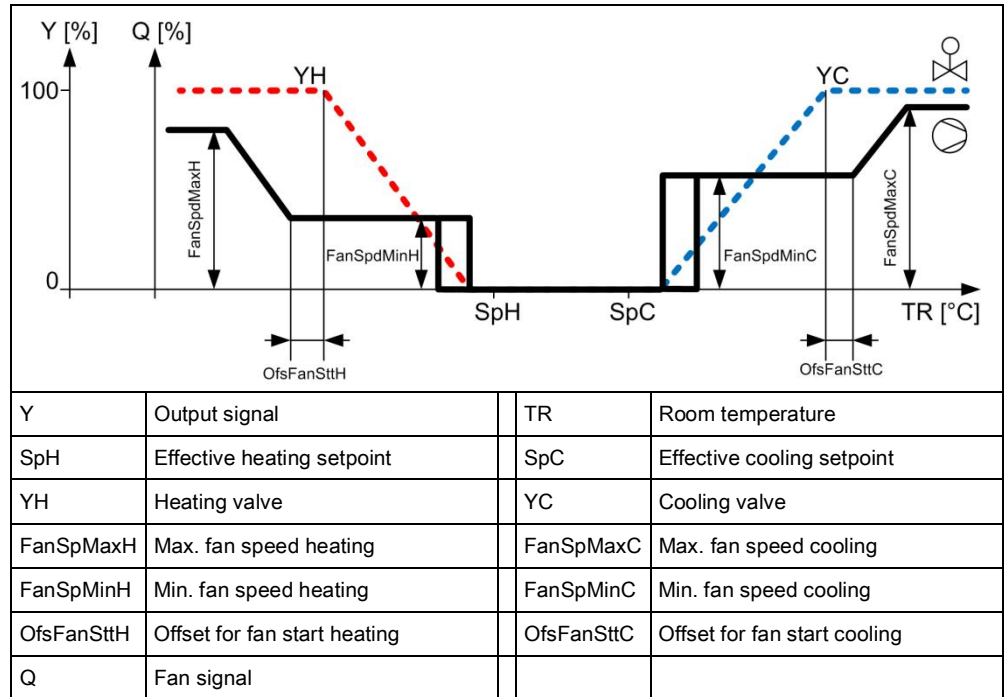

Figure: Example of a serial control strategy using a modulating fan

Parallel

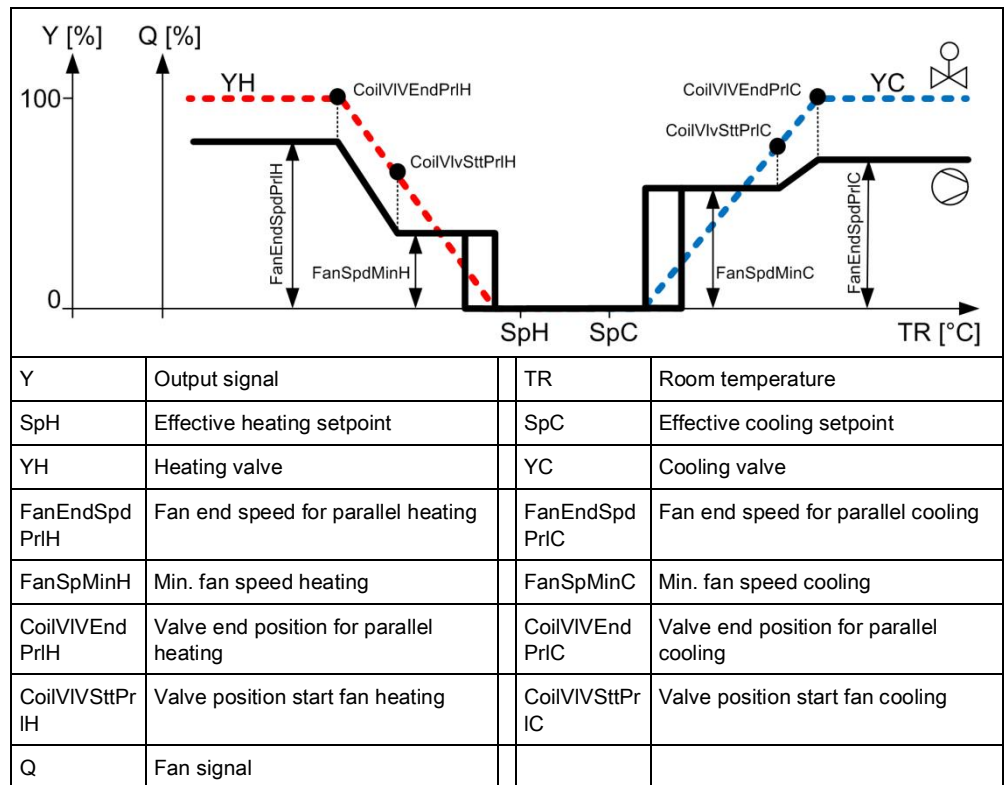

Figure: Example of a parallel control strategy using a modulating fan

The control strategy can be configured in the application using the following parameters for the cooling sequence and heating sequence.

Description	Name	Default value
Fan operation for cooling 0:Serial 1:Parallel	FanOp	1:Parallel
Fan operation for heating 0:Serial 1:Parallel	FanOp	1:Parallel

## 16.2 Air volume flow in the dead zone

The fan coil application configures a minimum supply air flow in the temperature control dead zone. The function can be configured individually for all room operating mode.

Description	Name	Default value
Minimum supply air Comfort 1:Off 2:Minimum ventilation 3:Demand-controlled ventilation 4:Minimum ventilation & demand-controlled ventilation	CmfCnf	4: Minimum ventilation & demand-controlled ventilation
Minimum supply air for Pre-Comfort	PcfCnf	3:Demand-controlled ventilation
Minimum supply air Economy	EcoCnf	1:Off
Minimum supply air Protection	PrtCnf	1:Off

Minimum fan speed for all room operating modes is also configured.

Description	Name	Default value
Minimum fan speed for ventilation	FanSpdMinVnt	50 [%]

## 16.3 Control of staged fan

Fan coil applications in the DXR2 include one to three-stage automatic fan control. The fan stages are switched on or off with potential free relay contacts.

### Sequences

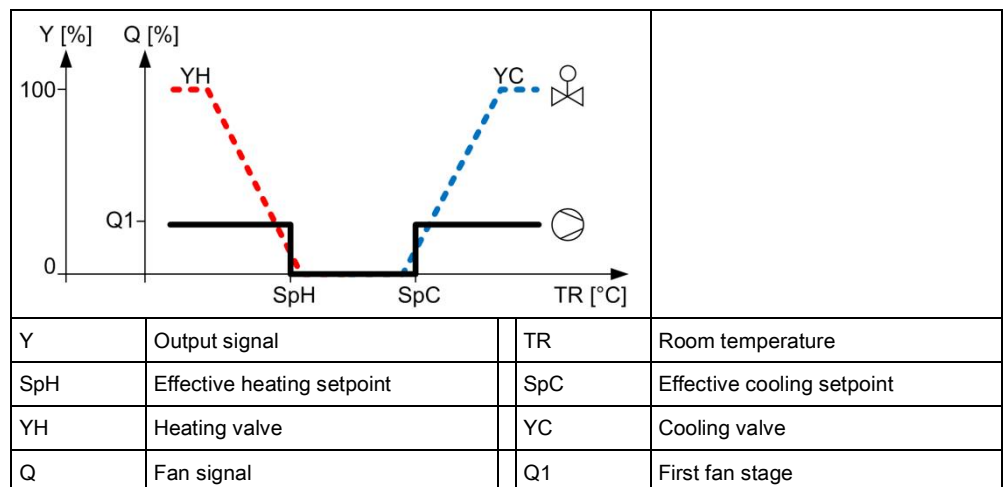
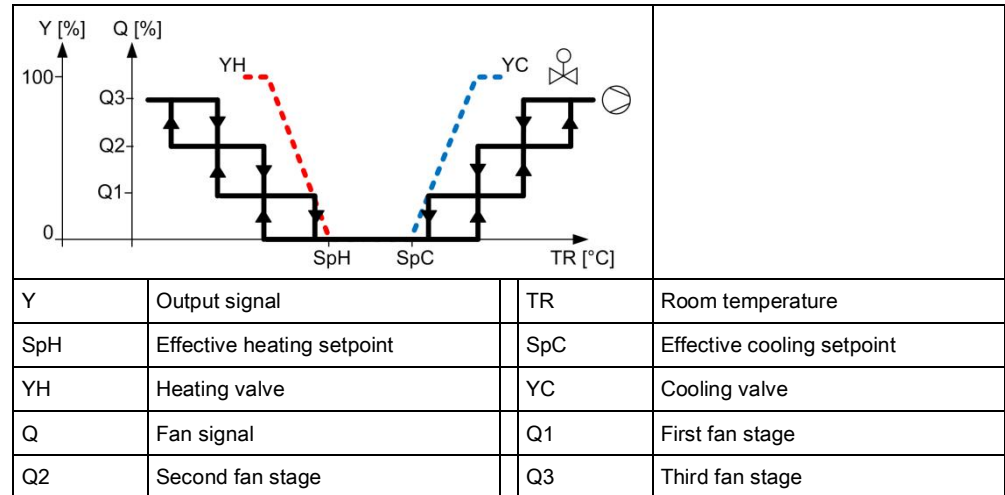

Figure: 1-stage fan sequence



**Figure: 3-stage fan sequence**

### Outputs

Staged fans are switched by relays or relays on the DXR2.

### Minimum runtime

Each fan stage is always switched on for a specific minimum time before changing over to the next higher stage. So that the room controller acquire control at this stage. The time is fixed at 15 seconds on all DXR2 applications.

### Switch-off delay

The switch off of a fan is delayed for a specific period on applications that have electric heating coils/reheaters. This cools down the electric heating coils/reheater with circulating air. The switch-on/switch-off time can be configured.

Description	Name	Default value
Switch-off delay holding signal for air volume flow heating	DlyOffAfIHidH	30 [s]

### Return air sensor

The fan must be switched on if room temperature measurement is made using a return air sensor in the fan coil system, to correctly acquire the actual room temperature. A minimum air volume is enabled in the dead zone by default for the operating mode Comfort on the DXR2. The parameter cannot be changed when using a return air sensor to measure room temperature.

In this case, note that a conventional room temperature sensor must be configured at the DXR2 input. The return air temperature sensor is then connected instead of the room temperature sensor. The room is now temperature controlled per the measured value from the return air sensor.

DXR2 does not support interval-type fan activities to periodically measure room temperature with the return air sensor.

Also note that DXR2 temperature control in the room can only have one measured return (temperature sensor) which is always configured and connected at the input of the room temperature sensor. The available configuration for a return air sensor is used for visualization on DXR2.

### Locked by electric heating coils

Locking is a binary signal to protect fan coil equipment. The application locks electric heating coils even if no air flow is available through the fan. Or enabled if air flow is available through the fan.



**Start of fan by heating demand**

The fan is started for active heat or refrigeration demand in the room. The signal is sent to the fan from the heat or refrigeration register.

Description	Name
Display of heat/cooling request in the room. It starts the fan to meet the heat request.	AirFIHReq / AirFICReq

## 16.4 Control of modulating fan

The DXR2 fan coil applications can automatically control modulating fans (DC 0...10V). In addition, the fan can be enabled or locked with a potential free relay contact.

**Sequences**

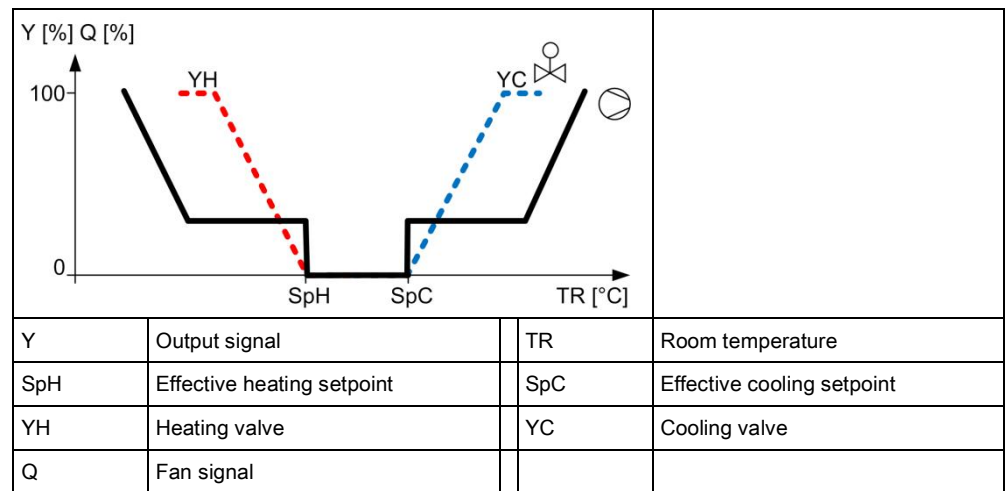

**Figure: Modulating fan sequence**

**Outputs**

Analog outputs on the DXR2 control modulating fans.

**Switch-off delay**

The switch off of a fan is delayed for a specific period on applications that have electric heating coils/reheaters. This cools down the electric heating coils/reheater with circulating air. The switch-on/switch-off time can be configured.

Description	Name	Default value
Switch-off delay holding signal for air volume flow heating	DlyOffAflHldH	30 [s]

**Return air sensor**

The fan must be switched on if room temperature measurement is made using a return air sensor in the fan coil system, to correctly acquire the actual room temperature. A minimum air volume is enabled in the dead zone by default for the operating mode Comfort on the DXR2. The parameter cannot be changed when using a return air sensor to measure room temperature.

In this case, note that a conventional room temperature sensor must be configured at the DXR2 input. The return are temperature sensor is then connected instead of the room temperature sensor. The room is now temperature controlled per the measured value from the return air sensor.

DXR2 does not support interval-type fan activities to periodically measure room temperature with the return air sensor.

Also note that DXR2 temperature control in the room can only have one measured return (temperature sensor) which is always configured and connected at the input of the room temperature sensor. The available configuration for a return air sensor is used for visualization on DXR2.

**Locking**

Locking is a binary signal to protect fan coil equipment. The application locks the electric heating coils if no air flow is available or enables if available.

## 16.5 Water register for 4-pipe system

**Plant diagram**

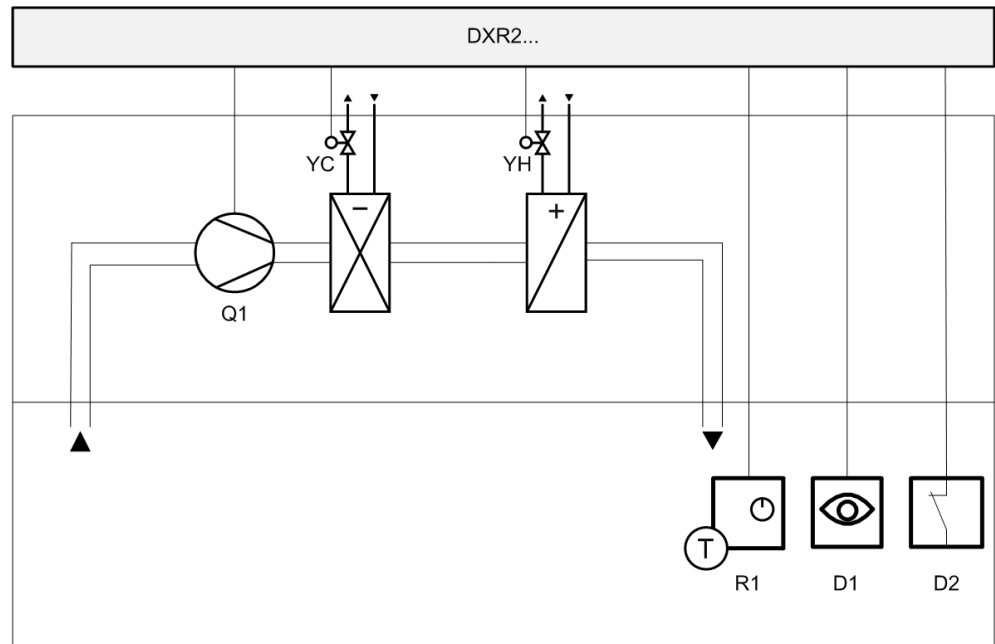
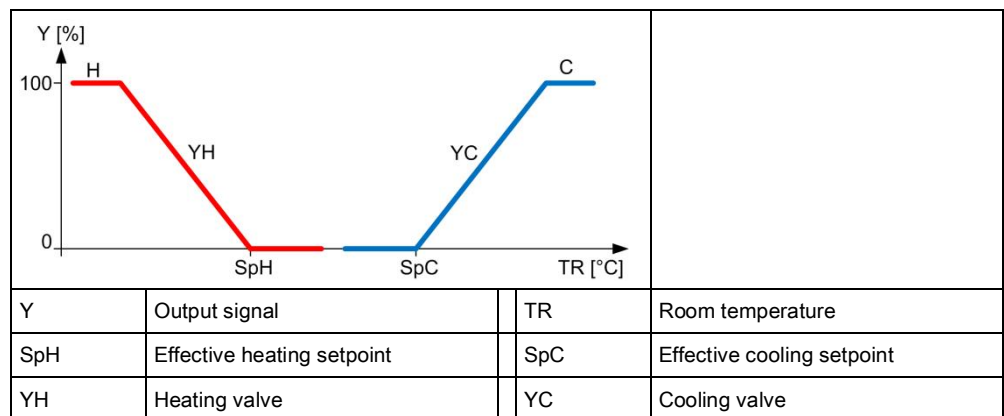

**Figure: 4-pipe system fan coil applications**

Key:

DXR2...	Room automation station	R1	Room operator unit
Q1	Fan	D1	Presence
YC	Chilled water cooling coils	D2	Window contact
YH	Hot water heating coils		

**Sequences**



**Figure: Modulating heating and cooling sequence**

## 16.6 Water register 2-pipe system with changeover

Plant diagram

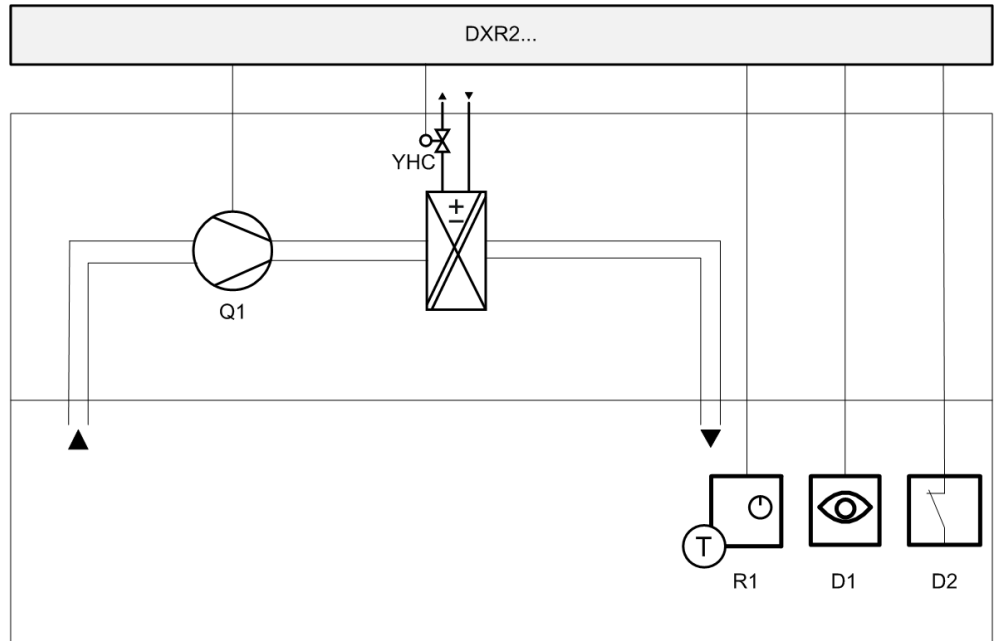

Figure: 2-pipe system fan coil applications with changeover

Key:

DXR2...	Room automation station	R1	Room operator unit
Q1	Fan	D1	Presence
YHC	Heating/cooling coils	D2	Window contact

Sequences

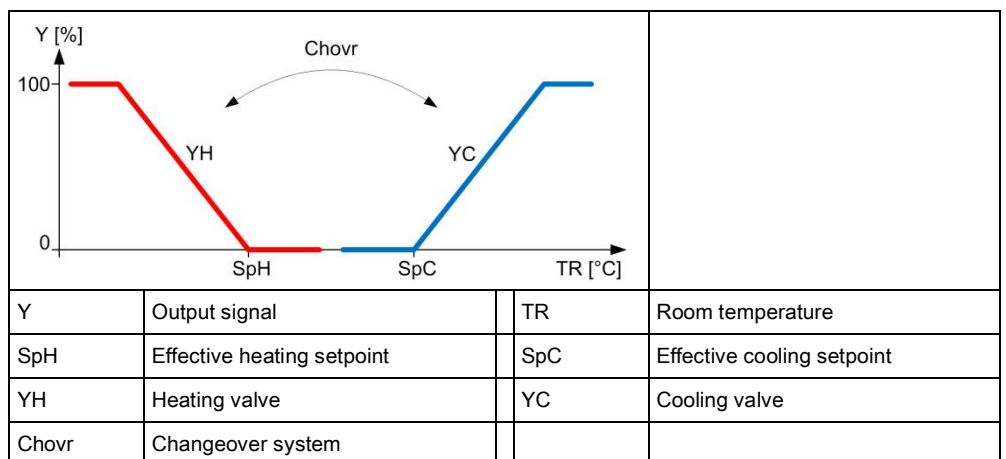

Figure: Modulating heating and cooling sequence with changeover system

## 16.7 Water register for 4-pipe system with changeover valves

Plant diagram

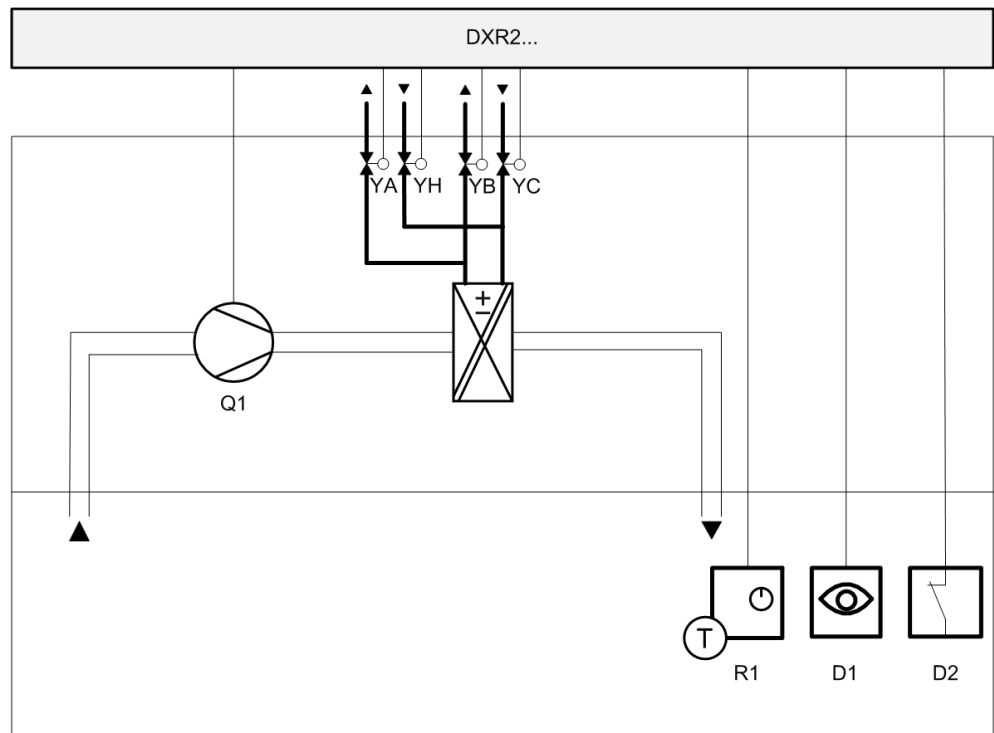

Figure: Example of water register 4-pipe system with changeover valves

Key:

DXR2...	Room automation station	R1	Room operator unit
YH	Heating valve	D1	Presence
YA	Changeover valve heating	D2	Window contact
YC	Cooling valve	Q1	Fan
YB	Changeover valve cooling		

Sequences

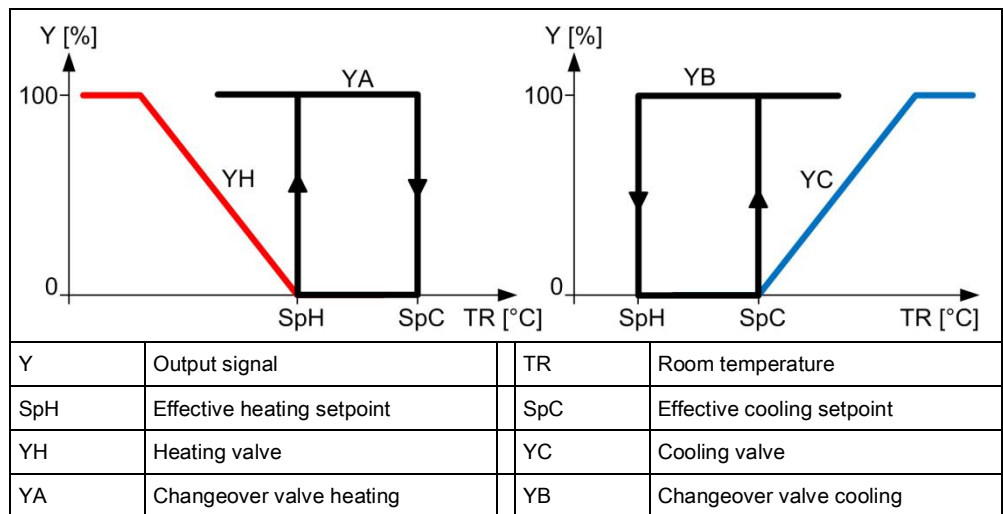

Figure: Modulating heating and cooling sequence

## 16.8 Water register 4-pipe system with 6-port valve

Plant diagram

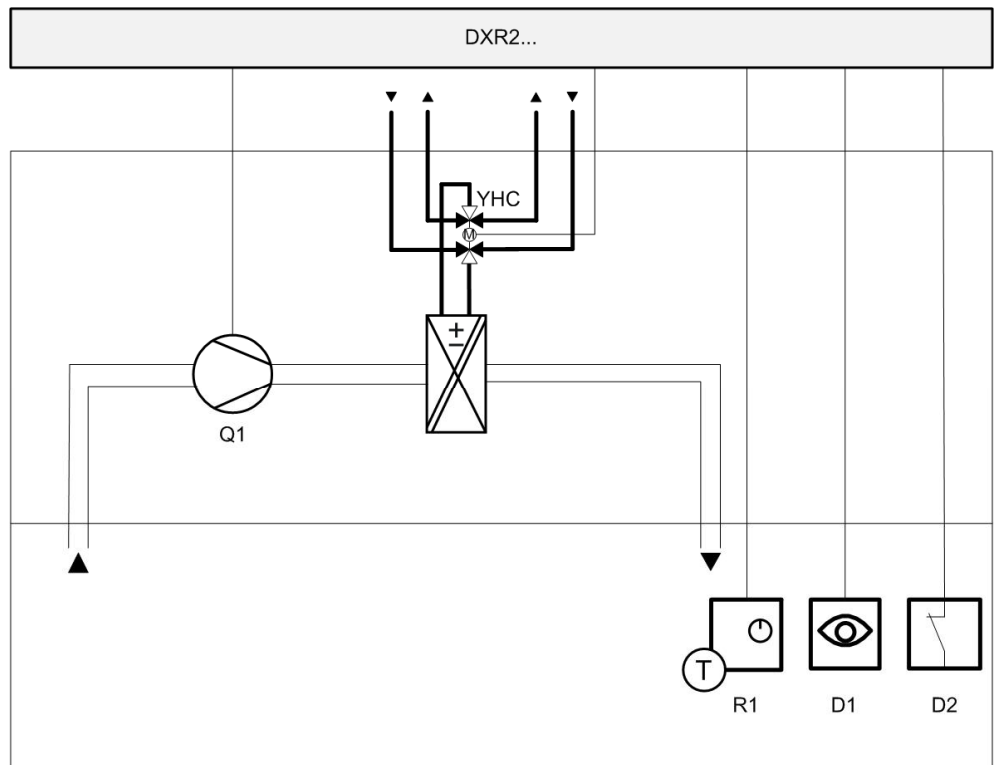

Figure: Example for a 4-pipe system fan coil applications with a 6-port valve

Key:

DXR2...	Room automation station	R1	Room operator unit
YHC	6-port valve	D1	Presence
		D2	Window contact

Sequences

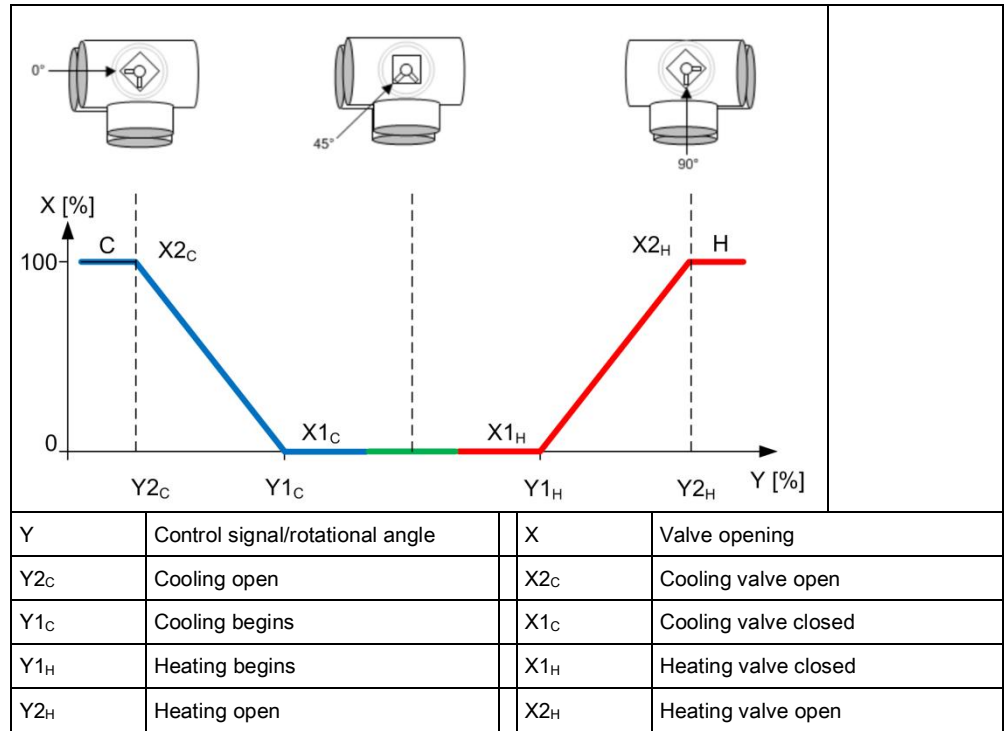

Figure: Modulating heating and cooling sequence with 6-port valve positions

Parameter settings

Description	Name	Default value
Cooling coil valve position X1c	X1CcIVlvPos	0 [%]
Cooling coil valve position Y1c	Y1CcIVlvPos	50 [%]
Cooling coil valve position X2c	X2CcIVlvPos	100 [%]
Cooling coil valve position Y2c	Y2CcIVlvPos	0 [%]
Heating coil valve position X1h	X1HcIVlvPos	0 [%]
Heating coil valve position Y1h	Y1HcIVlvPos	50 [%]
Heating coil valve position X2h	X2HcIVlvPos	100 [%]
Heating coil valve position Y2h	Y2HcIVlvPos	100 [%]

## 16.9 Water register 2-pipe system, cooling only

Plant diagram

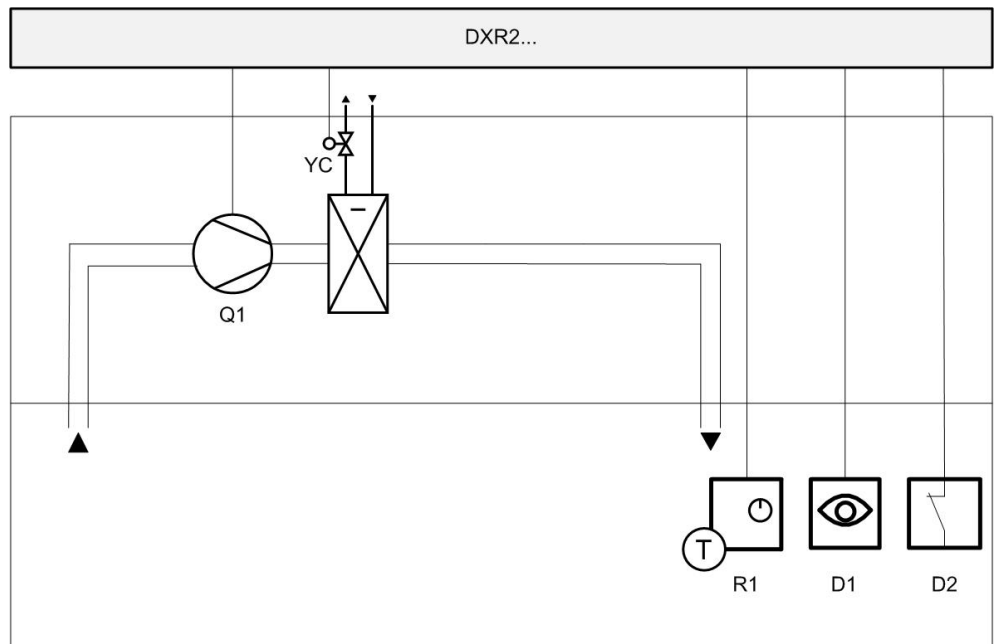

Figure: 2-pipe system fan coil applications, cooling only

Key:

DXR2...	Room automation station	R1	Room operator unit
Q1	Fan	D1	Presence
YC	Chilled water cooling coils	D2	Window contact

Sequences

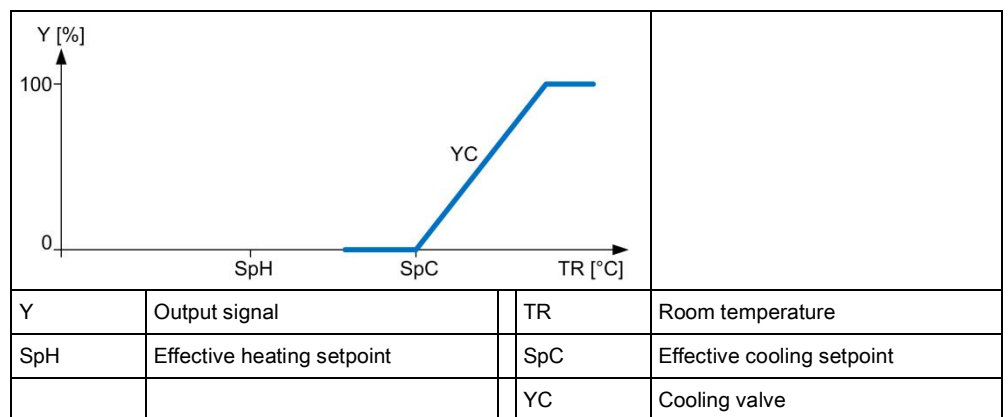

Figure: Modulating cooling sequence

## 16.10 Water register 2-pipe system, heating only

### Plant diagram

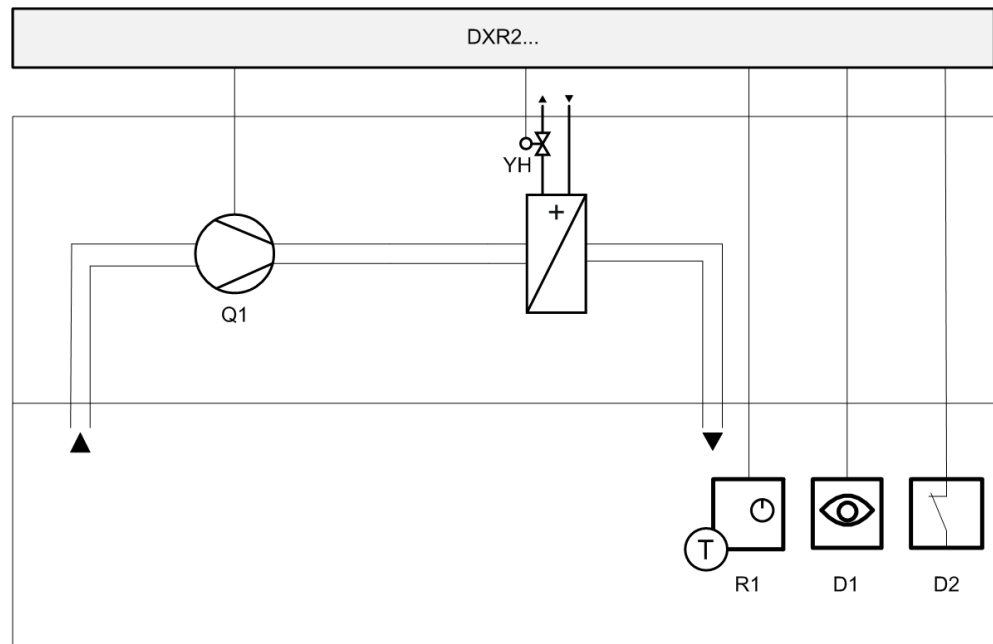

Figure: 2-pipe system fan coil applications, heating only

Key:

DXR2...	Room automation station	R1	Room operator unit
Q1	Fan	D1	Presence
YH	Hot water heating coils	D2	Window contact

### Sequences

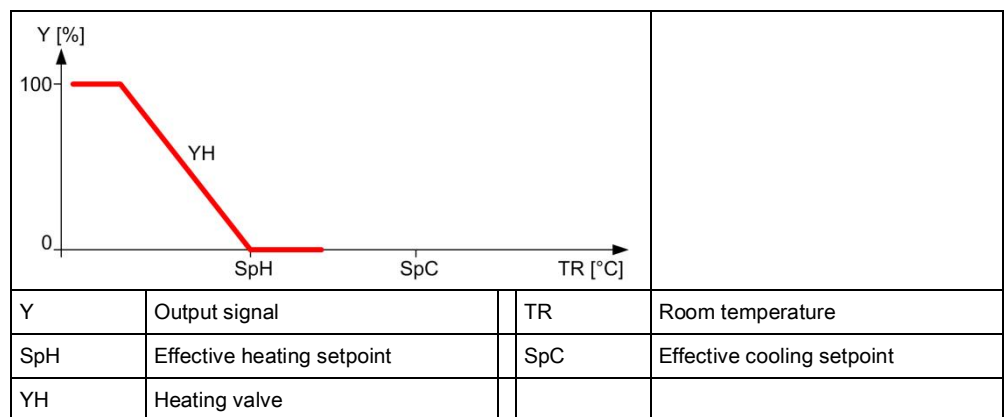

Figure: Modulating heating sequence

## 16.11 Actuators

The DRX2 automation station controls heating/cooling valves via Triac or analog outputs, regardless of available I/Os. 3-position actuators, thermal pulse width modulation (PWM) actuators, PWM actuators with return spring can be connected to the Triac outputs.

A maximum of 1 thermal valve can be connected to each Triac on the DXR2 automation station with AC 230 V power.

Conventional 0...10V actuators as well as 6-port valves can be connected to analog outputs.



## 16.12 Valve protection

Valve actuators are operated from time to time to prevent them from seizing after long periods of inactivity (e.g. heating valve during the summer). The valve actuator is controlled to lose as little heating energy as possible.

The central function for the hot water supply chain performs the valve protection function and can be changed in the parameters as needed.

Description	Name	Default value
Kick value	KickVal	50 [%]
Kick time	TiKick	2 min
Kick cycle	KickCyc	500 h

## 16.13 Determination of heating/cooling state

All DXR2 applications analyze heating/cooling state by comparing the present room temperature against the setpoints and active control sequence. The present state is displayed on the room operator unit and the BAC system.

A sequence controller prevent simultaneous heating/cooling.

## 16.14 Heating/cooling demand

Each DXR2 automation station calculates heating and cooling demand for a room and makes the result available through a group of the central function (supply chain hot water/chilled water).

### Outside air temperature dependent heating curve

The hot water demand setpoint is calculated in the central function using a heating curve based on the outside temperature.

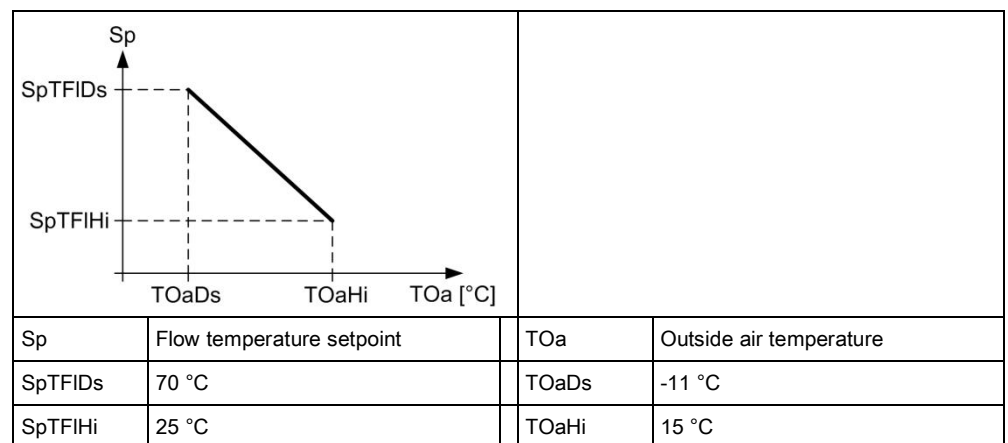

Figure: Characteristic curve for the outside temperature-dependent heating curve

### Demand correction by collected valve positions

Valve positions in the various rooms correct the demand setpoint in the central function based on the number of valves between a value of 70...100%.

Description	Name	Default value
Setpoint correction, if 100% of all consumers are within 70...100%.	SpCorrTFIHi	5 [K]
Setpoint correction, if 0% of all consumers are within 70...100%.	SpCorrTFILo	-5 [K]

## 16.15 Preheating

The central functions can trigger the preheating function to heat up a room at end of the night setback period as quickly as possible to the Pre-Comfort setpoint. This impacts the plant operating mode of the application.

## 16.16 Emergency operation

The setpoint for protection ensures that room temperatures do not change below or above a critical limit.

## 16.17 Night cooling

The plant operating mode cools a room using cooling outside air. The central function sends a "Night cooling request" to the group member rooms. The decision as to whether night cooling makes sense and is energy efficient is made at the central function. Various coordination signals between the primary plant and room automation do the following via central functions:

- Switch on the fans,
- Set the mixed air dampers to 100% outside air,
- Lock all other equipment including heating coils, cooling coils, humidifier.

Night cooling only occurs under the following conditions:

- The room is vacant (Economy or Protection).
- The outside temperature is above an adjustable setpoint of 9 °C.
- The temperature difference to cooling is sufficiently large, i.e. room temperature - outside temperature > 7 K.
- The temperature deviation from room temperature and temperature setpoint is sufficiently large, i.e. room temperature > room setpoint + 2 K.

Description	Name	Default value
Night cooling 0:Inactive 1:Active	NgtCReq	0:Inactive

## 16.18 Free cooling

The function free cooling to take advantage of cooling generated without effort to cool the rooms to a room temperature setpoint. Dew point compensation is still available for the chilled water temperature setpoint dependent on active dew point detector via the grouping function.

This supply chain is continued accordingly, in other words chilled water generation (chillers, refrigeration machines, etc.) are also controlled based on demand.

## 16.19 Reset setpoint

The central function can reset a local change to a setpoint on the room operator unit. The management station can manually reset the value or the reset can also be automatic by a scheduler. Setpoints for room temperature, ventilator stage, and room operating mode can be reset.

## 16.20 Free inputs/outputs

Inputs and outputs can be configured as free inputs on all DXR2s. This permits the querying of unused input and output switching states or directly controlling another device over BACnet.

## 16.21 Centrally override valves

Central functions permit the central override of all valve in the supply group. The following parameters can be used.

Description	Name	Default value
Enable valve position override	EnVlvPosOvrr	0:No 1:Yes
Valve position override	VlvPosOvrr	100 [%]

## 16.22 Electric heating coil

One electric heating coil can be configured for fan coil applications. The DRX2 automation station controls electric heating coils via Triac or analog outputs, regardless of available I/Os. Single-stage, 2-stage, and modulating electric heating coils are supported.

Plant diagram

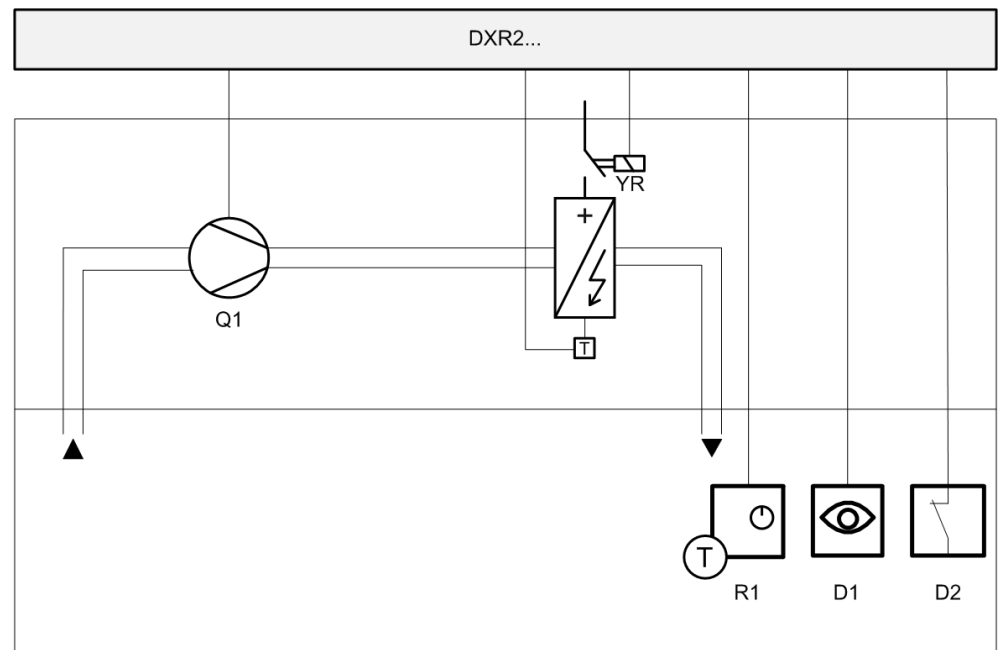

Figure: Example of a fan coil application with electric heating coils

Key:

DXR2...	Room automation station	R1	Room operator unit
Q1	Fan	D1	Presence
YR	Electric heating coil	D2	Window contact
T	Over temperature contact		

Sequences

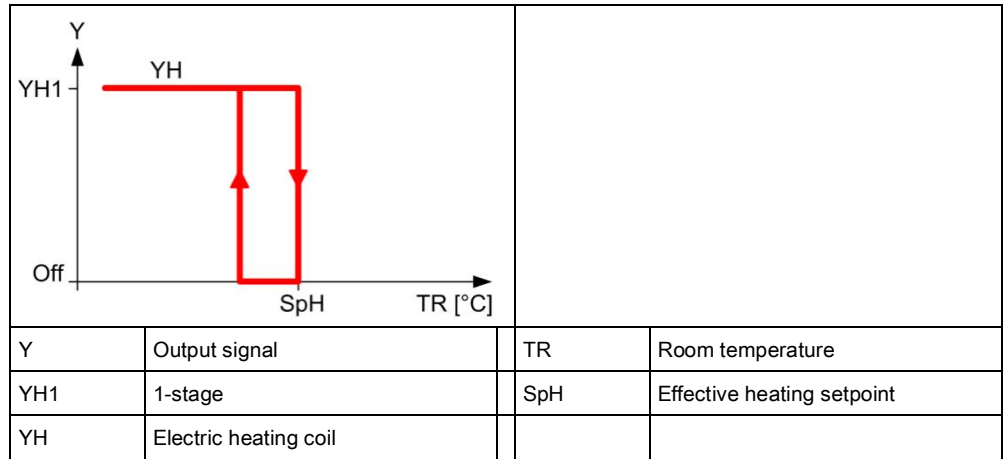

Figure: 1-stage electric heating coils

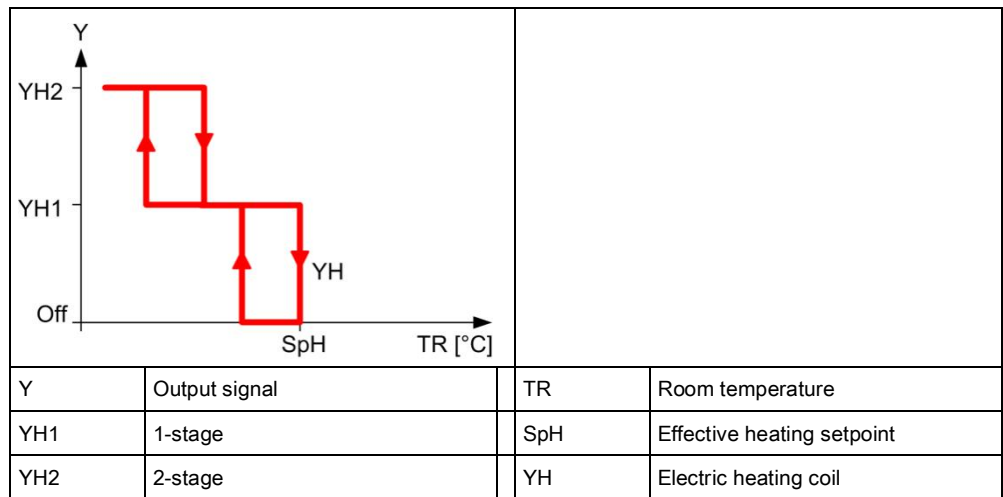

Figure: 2-stage electric heating coils

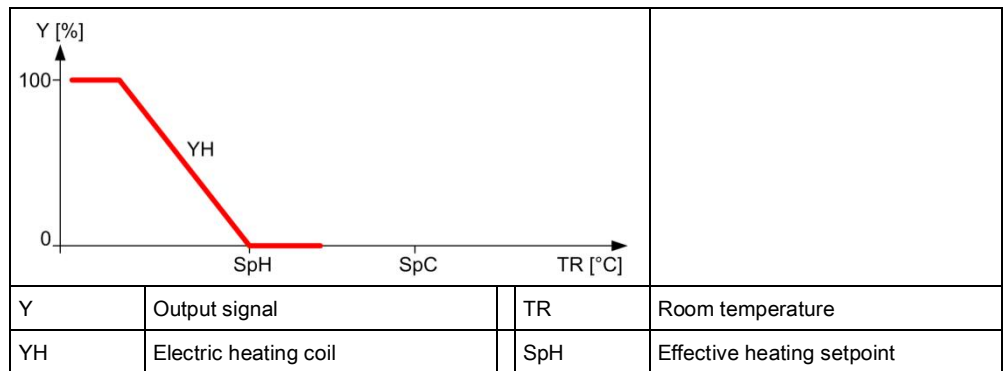

Figure: Modulating electric heating coils

Actuators

Electric heating coils, controlled via an analog output on the DXR2, can receive an enable via a relay or Triac on the DXR2. A binary overtemperature protection can be connected on the DXR2 for all versions of the electric heating coils application.

**Safety thermostat**

A binary overtemperature (open contact) protection can be connected on the DXR2 for all versions of the electric heating coil application. The application switches off the electric heating coils at device protection priority if overtemperature protection is enabled.

Description	Name	Default value
Enable overtemperature input 0:No 1:Yes	EnOvrTDetIn	0:No

## 16.23 Electric reheater

DXR2 applications permit control of electric heating coils, in addition to control of water heating valves and/or heating/chilled water valves. They are then operated as reheaters and only enabled if the water heating valve is fully open.

**Plant diagram**

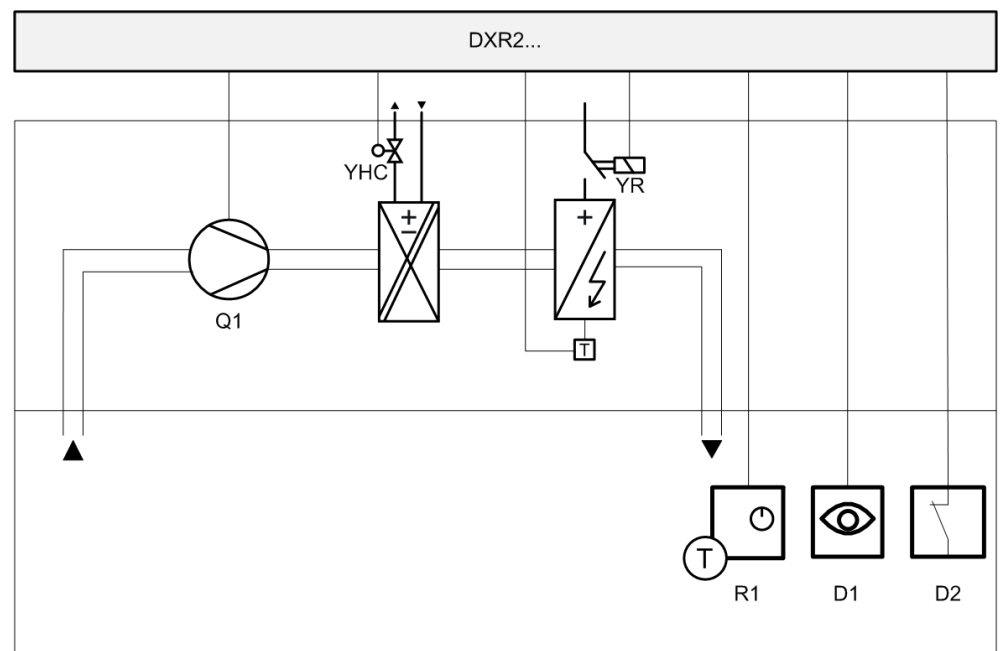

**Figure: Example for a 2-pipe system fan coil application with electric reheater**

Key:

DXR2...	Room automation station	R1	Room operator unit
Q1	Fan	D1	Presence
YHC	Heating/cooling coils	D2	Window contact
YR	Electric heating coil	T	Over temperature contact

## Sequences

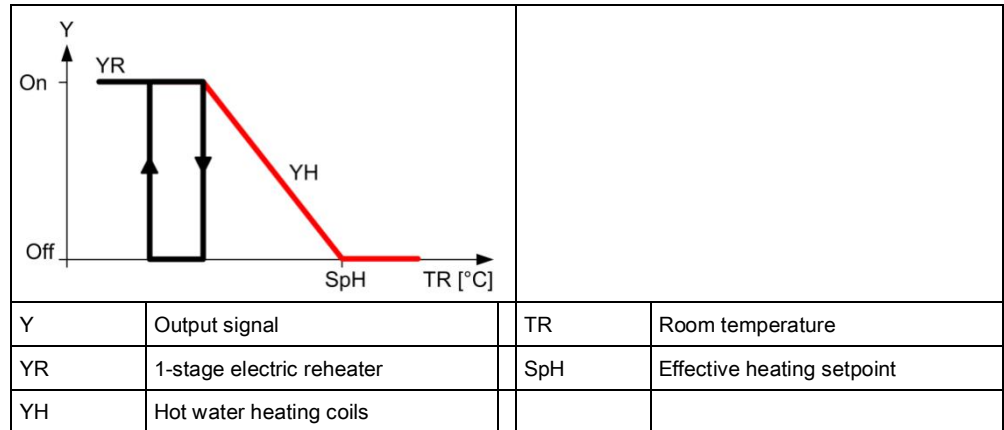

Figure: 1-stage electric reheater

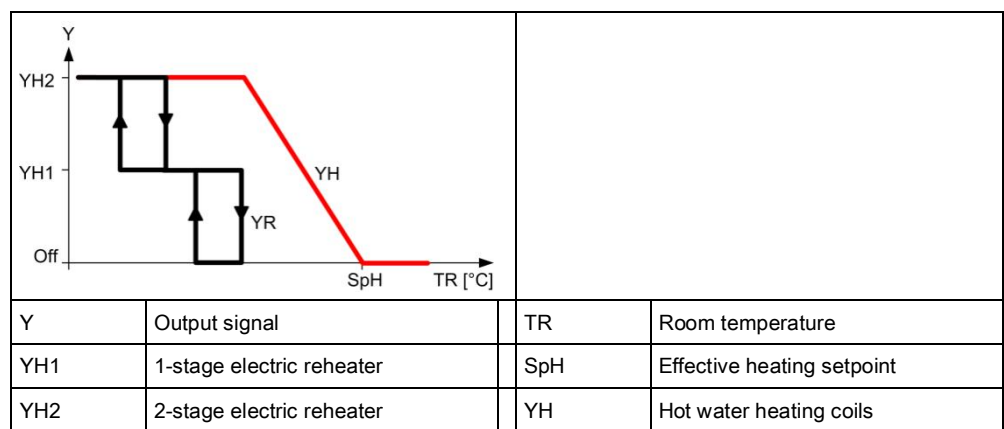

Figure: 2-stage electric reheater

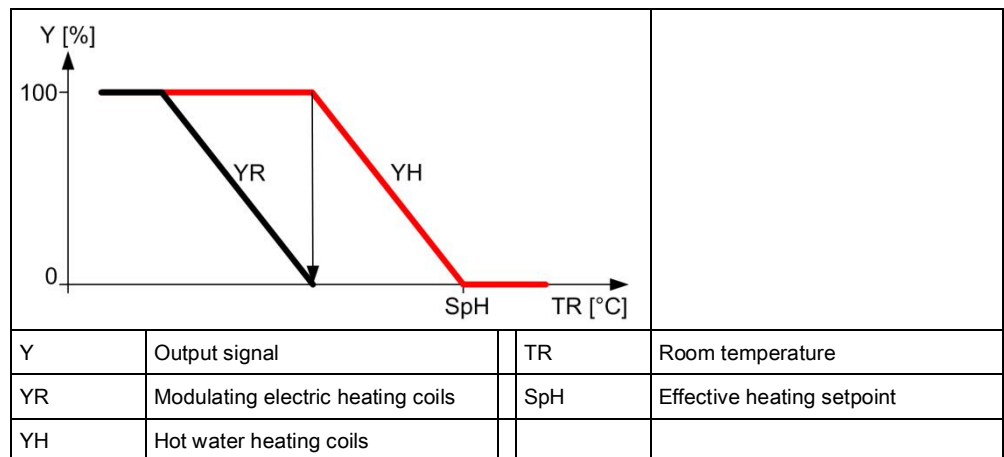

Figure: Modulating electric reheater

## Actuators

Electric heating coils, controlled via an analog output on the DXR2, can receive an enable via a relay or Triac on the DXR2. A binary overtemperature protection can be connected on the DXR2 for all versions of the electric heating coils application.

## Safety thermostat

A binary overtemperature (open contact) protection can be connected on the DXR2 for all versions of the electric reheater application. The application switches off the electric reheater at device protection priority if overtemperature protection is enabled.

Description	Name	Default value
Enable overtemperature input 0:No 1:Yes	EnOvrTDetIn	0:No

## 16.24 Room supply air cascade

Room supply air cascade quickly achieves the room temperature setpoint. The room controller calculates a setpoint from the room temperature as measured at the air outlet of the air system. The temperature can be limited to prevent the inflow of unpleasantly cool or warm air into the room.

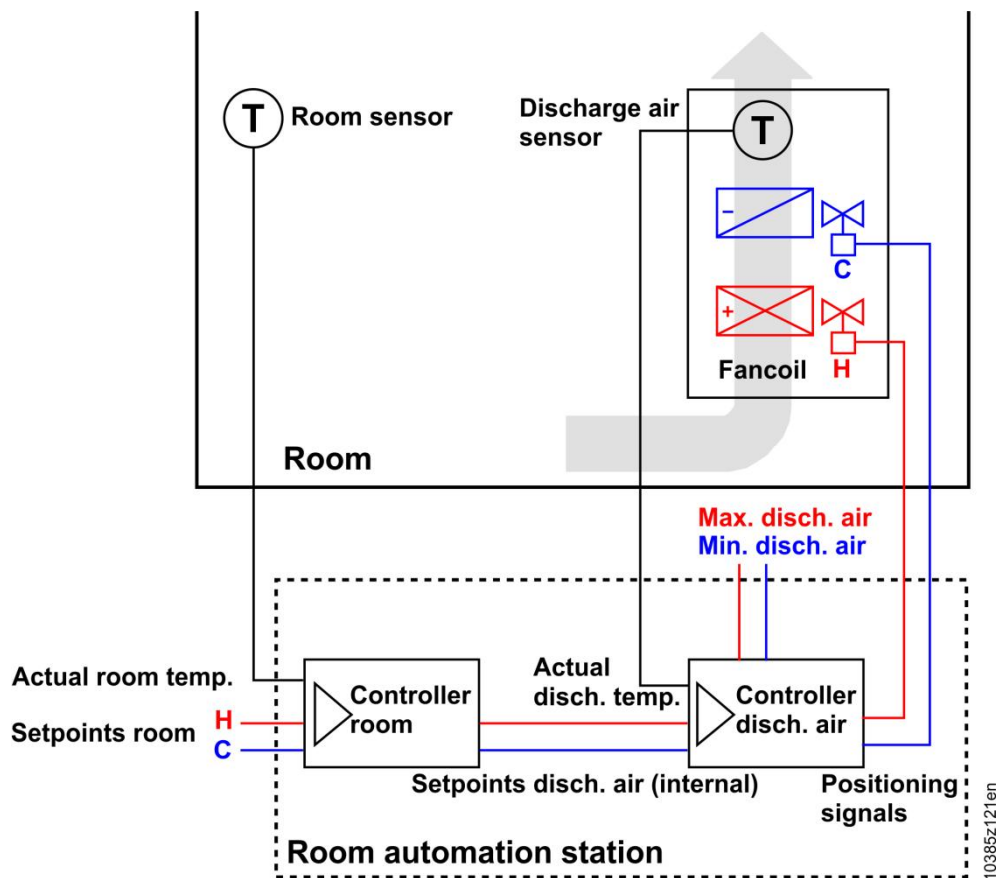

Figure: Plant diagram for supply air cascade control

10385z121en

## 16.25 Air quality control

The fan coil unit application can be used for air quality control. It requires an outside air damper capable of supplying the room with fresh air and an air quality sensor in the room. The application automatically enabled air quality control as soon as an air quality sensor and an outside damper is configured.

### Setpoints

Air quality setpoints can be configured separately for each room operating mode.

Description	Name	Default value
Room air quality setpoint for Comfort	SpAQualRCmf	900 ppm
Room air quality setpoint for Pre-Comfort	SpAQualRPcf	1100 ppm
Room air quality setpoint for Economy	SpAQualREco	1500 ppm
Room air quality setpoint for Protection	SpAQualRPrt	1500 ppm

### Minimum positions for outside air damper

The minimum outside air damper position can also be configured for each room operating mode.

Description	Name	Default value
Minimum outside air damper position for Comfort	DmpOaPosMinCmf	50 [%]
Minimum outside air damper position for Pre-Comfort	DmpOaPosMinPcf	40 [%]
Minimum outside air damper position for Economy	DmpOaPosMinEco	30 [%]
Minimum outside damper position Protection	DmpOaPosMinPrt	20 [%]

## 16.26 Dehumidification control

The application function for fan coil applications lowers the relative humidity by overriding the coiling coil valve position and setting the fan to the correct speed for dehumidification. The integrated PID controller compares relative room humidity with the setpoint corresponding to the active room operating mode. The PID controller operating mode is set to 2-point (off/dehumidification) to activate maximum output if the temperature for dehumidification must be lowered.

The cooling coils are controlled with the command to dehumidify, while also coordinating that state with the controller that the cooling coils are ready for dehumidification.

A humidity sensor in the room is required for dehumidification control. The application automatically enables dehumidification control as soon as an humidity sensor and cooling coils are configured.

### Setpoints

Dehumidification setpoints can be configured separately for each room operating mode.

Description	Name	Default value
Relative room air humidity setpoint for Comfort	SpHuRelRCmf	65 % r.h.
Relative room air humidity setpoint for Pre-Comfort	SpHuRelRPcf	70 % r.h.
Relative room air humidity setpoint for Economy	SpHuRelREco	80 % r.h.
Relative room air humidity setpoint for Protection	SpHuRelRPrt	90 % r.h.



## 16.27 Outside air damper control

The outside air damper primary supplies the room with fresh outside air. It can also be used for take advantage of cooler outside air to cool the room.

The outside air damper is only opened if the fan is running. This can be based on a cooling request, dehumidification request, or fresh air request.

### Ramp-up time outside air damper

A configured limit prevents the damper from opening too quickly if the air is very cool. Closing and manual commanded are not prevented.

The ramp-up function is enabled if the outside temperature is below the switch-on point for the ramp-up damper or the outside temperature sensor is invalid.

Description	Name	Default value
Switch-on point for ramp-up function	SwiOnPtRup	5 [°C]
Ramp-up time outside air damper	TiRupDmpOa	2 [Min]

### Outside temperature-dependent limitation of outside air damper

The characteristic curve for the outside air damper can be limited by the outside temperature. The value can be adapted regardless of internal room load.

Description	Name	Default value
Output limitation characteristic curve for outside temperature X1	X1LmOutTOa	6 [°C]
Output limitation characteristic curve for damper position Y1	Y1LmOutDmpPos	20 [%]
Output limitation characteristic curve for outside temperature X2	X2LmOutTOa	18 [°C]
Output limitation characteristic curve for damper position Y2	Y2LmOutDmpPos	100 [%]

### Economizer

The Economizer function can be activated if the outside air is cold enough for cooling. The temperature of the outside air is distributed via the weather station central function to all rooms. The switch-on point for the Economizer can be defined by a parameter:

Description	Name	Default value
Minimum difference room temperature/outside temperature for cooling	DiffTRTOaMinC	0 [K]

The Economizer is disabled and the outside damper is moved to the minimum position if dehumidification uses the application. This dehumidifies more humid air from the zone through the cooling coils.

### Switch-on delay

The outside damper switch-on delay can be configured for fresh air demand and cooling demand.

Description	Name	Default value
Cooling request switch-on delay	DlyOnAirFICReq	30 [s]
Ventilation request cooling delay	DlyOnAflVntReq	30 [s]

## 16.28 Presence control

The HVAC application can also be controlled by presence through the use of a presence detector.

The HVAC application can be configured for each room to react to presence for each room and regardless of the room operating mode.

Description	Name	Default value
Presence operating mode for Comfort 1:None 2:Considered presence 3:Considered absence 4:Considered presence & absence	PscModCmf	4:Considered presence & absence
Presence operating mode Pre-Comfort	PscModPcf	4:Considered presence & absence
Presence operating mode for Economy	PscModEco	1:None
Present operating mode for Protection	PscModPrt	1:None

The applicable delays for the HVAC application in a room can also be configured for each room.

Description	Name	Default value
Switching delay for presence	SwiDlyPrst	5 Min
Switching delay for absence	SwiDlyAbst	5 Min

## 16.29 Application examples

These are the descriptions of HIT applications on <http://hit.sbt.siemens.com>.

Visit the Siemens Download Center [www.siemens.com/bt/download](http://www.siemens.com/bt/download) for the latest application configurations.

### 16.29.1 Fan coil unit

FCU021	Fan coil unit with staged fan, heating/cooling coil (2 pipe) on analog output	A6V10662231	<a href="#">en</a> <a href="#">de</a>
FCU022	Fan coil unit with variable fan, heating/cooling coil (2 pipe) on analog output	A6V10662231	<a href="#">en</a> <a href="#">de</a>
FCU031	Fan coil unit with staged fan, heating/cooling coil (2 pipe) on triac output and electric reheater	A6V10662235	<a href="#">en</a> <a href="#">de</a>
FCU032	Fan coil unit with variable fan, heating/cooling coil (2 pipe) on triac output and electric reheater	A6V10662233	<a href="#">en</a> <a href="#">de</a>
FCU041	Fan coil unit with staged fan, heating and cooling coil (4 pipe) on triac output	A6V10662235	<a href="#">en</a> <a href="#">de</a>
FCU042	Fan coil unit with variable fan speed, heating and cooling coil (4 pipe) on triac output	A6V10662233	<a href="#">en</a> <a href="#">de</a>
FCU043	Fan coil unit with staged fan, heating and cooling coil (4 pipe) on analog output	A6V10662231	<a href="#">en</a> <a href="#">de</a>
FCU044	Fan coil unit with variable fan, heating and cooling coil (4 pipe) on analog output	A6V10662231	<a href="#">en</a> <a href="#">de</a>
FCU045	Fan coil unit with staged fan, 6-way heating/cooling coil (4 pipe) on analog output	A6V10662231	<a href="#">en</a> <a href="#">de</a>
FCU046	Fan coil unit with variable fan, 6-way heating/cooling coil (4 pipe) on analog output	A6V10662231	<a href="#">en</a> <a href="#">de</a>
INT201	Fan coil unit with staged fan, heating and cooling coil (4 pipe) on triac output including lighting and blinds operation	A6V10662235	<a href="#">en</a> <a href="#">de</a>

## 17 VAV application

The VAV application can be configured using a VAV application type. Each VAV application type can also combine a radiant/chilled ceiling or radiator application. The image below provides an overview of the VAV application type with all possible HVAC components that can be configured for a VAV application. The configuration enabled the applicable (required) aggregate on the DXR2.

### Plant diagram

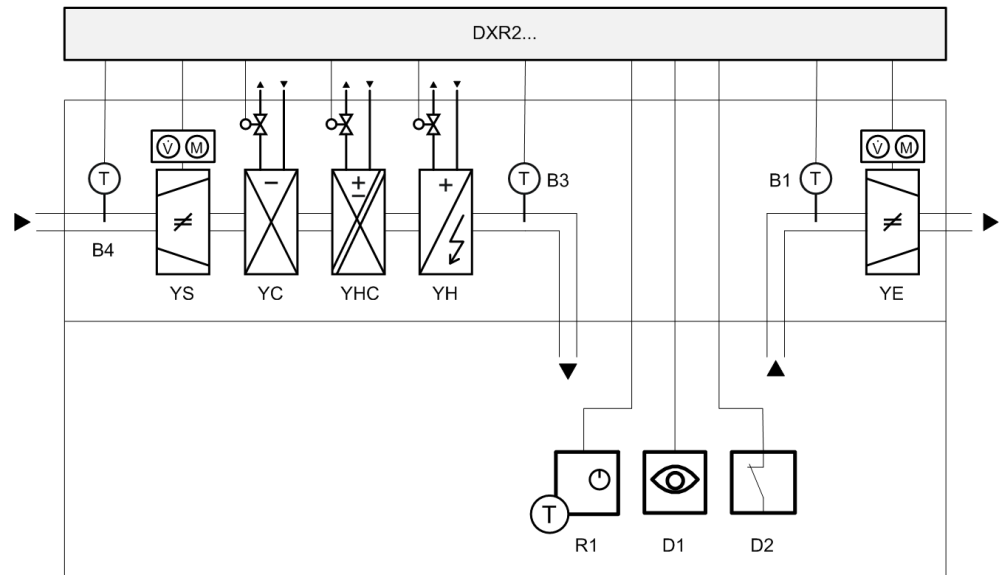

Figure: Application types for VAV applications

Key:

DXR2...	Room automation station	B4	Primary air temperature
B1	Return air temperature sensor	R1	Room operator unit
B3	Supply air sensor	D1	Presence
YC	Chilled water cooling coils	D2	Window contact
YHC	Heating/cooling coils	YS	VAV supply air
YH	Hot water heating coils or electric heating coils	YE	VAV extract air

### 17.1 Serial or parallel control strategy

You must select one of 2 different control strategies on all VAV applications:

- Serial fan operation: The air volume is only increased if the valve's or reheater's positioning signal is fully open and the room temperature exceeds or breaches an additional offset.
- Parallel fan operation: The fan speed is increased in parallel to the valve's or repeater's positioning signal.

The two strategies are illustrated in the following example using a heating and cooling valve.

Serial

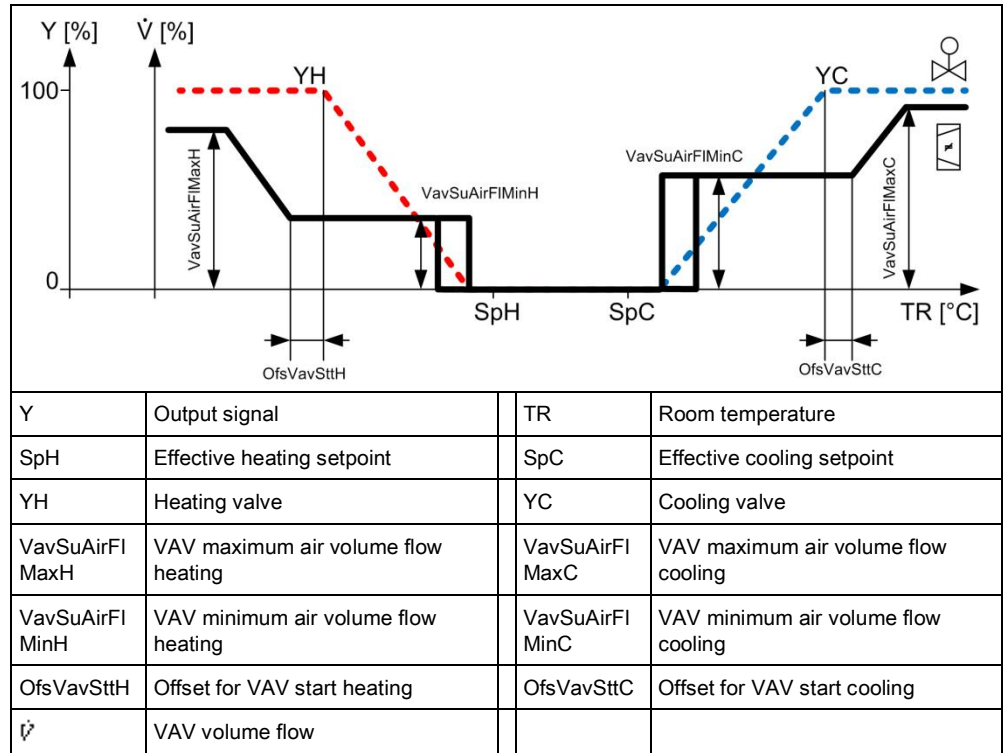

Figure: Example of a serial control strategy using modulating VAV

Parallel

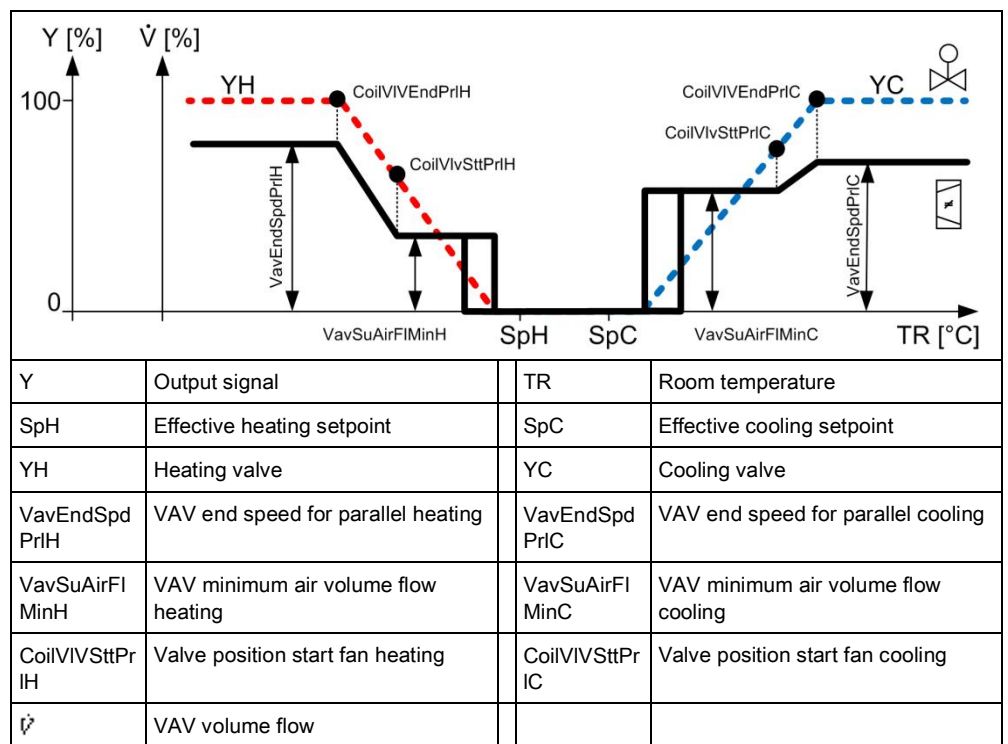

Figure: Example of a parallel control strategy using modulating VAV

The control strategy can be configured in the application using the following parameters for heating sequence.

Description	Name	Default value
Operating variables volume flow system for cooling 0:Serial 1:Parallel	VavOp	1:Parallel
Operating variables volume flow system for heating 0:Serial 1:Parallel	VavOp	1:Parallel

## 17.2 Air volume flow in the dead zone

The VAV application configures a minimum supply air flow in the temperature control dead zone. The function can be configured individually for all room operating mode.

Description	Name	Default value
Minimum supply air Comfort 1:Off 2:Minimum ventilation 3:Demand-controlled ventilation 4:Minimum ventilation & demand-controlled ventilation	CmfCnf	4:Minimum ventilation & demand-controlled ventilation
Minimum supply air for Pre-Comfort	PcfCnf	3:Demand-controlled ventilation
Minimum supply air Economy	EcoCnf	1:Off
Minimum supply air Protection	PrtCnf	1:Off

Minimum air volume flow for all room operating modes is also configured.

Description	Name	Default value
Supply air VAV minimum air flow for ventilation	VavSuAflMinVnt	0 [m <sup>3</sup> /h] 0.00 [l/s]

Sequence with modulating heating valve

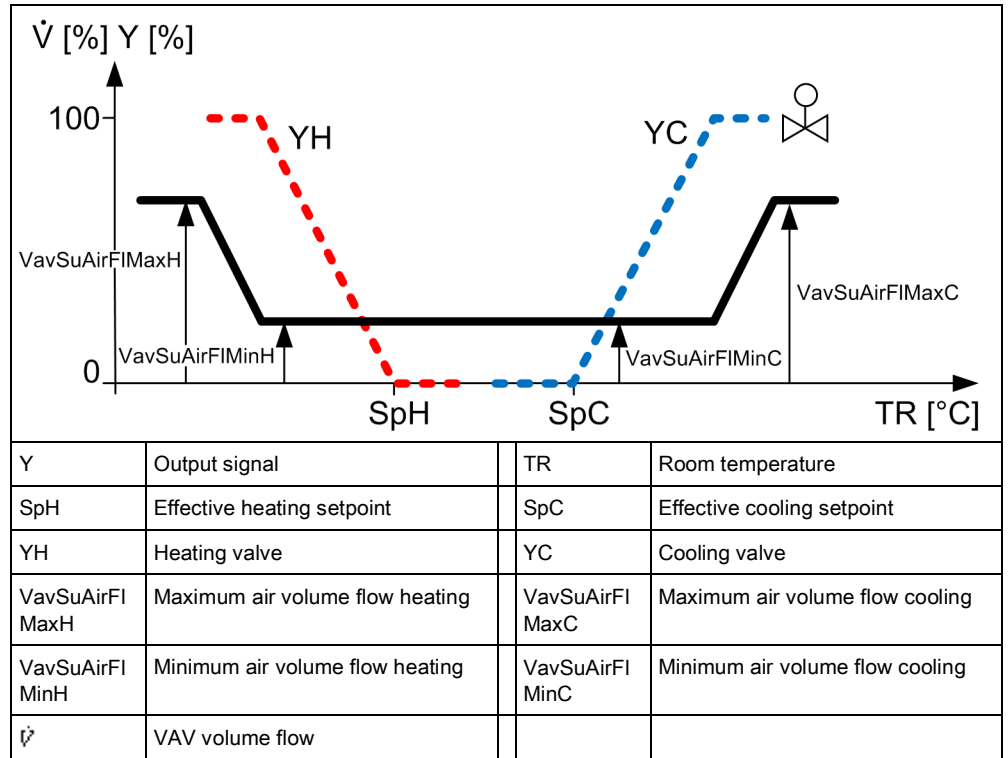

Figure: Serial control sequence for a VAV application with modulating heating valve

Sequence with 2-stage heating valve

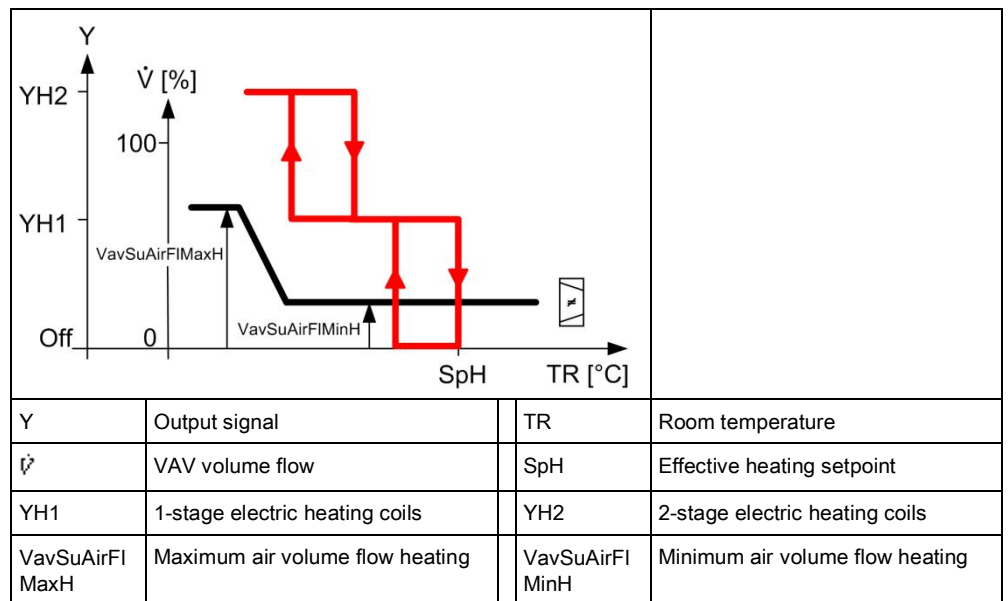

Figure: Serial control sequence for a VAV application with 2-stage heating valve

## 17.3 Volume flow setpoints heating/cooling

The volume flow setpoints for heating or cooling sequence can be defined independent of one another. The values are not interdependent.

### Volume flow setpoints

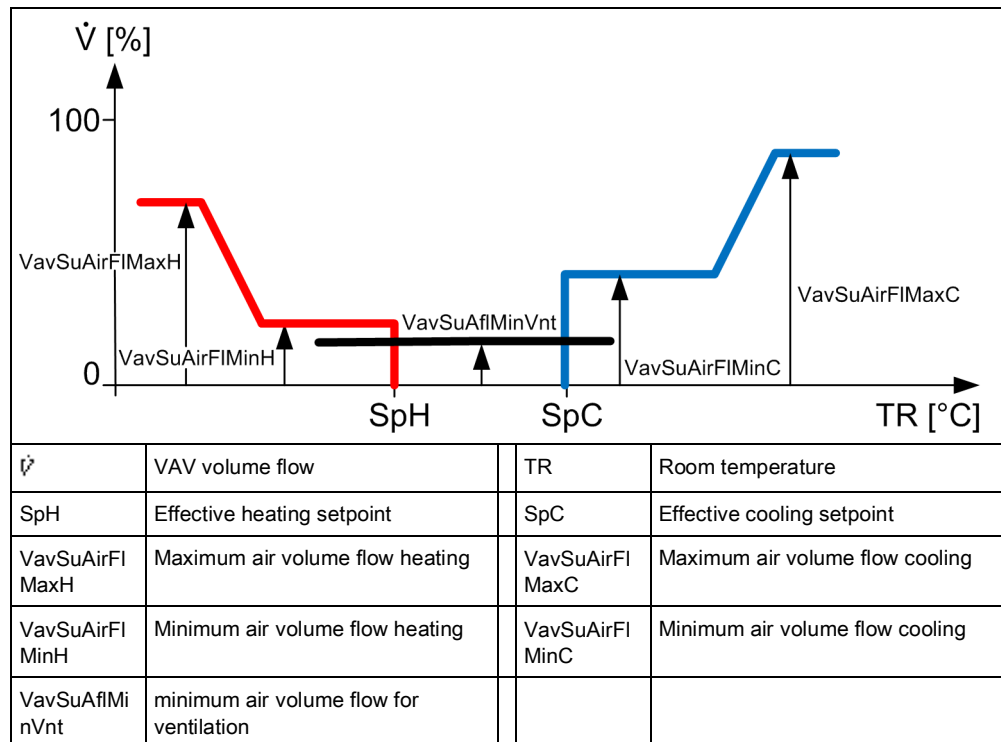

Figure: Serial control sequence for a VAV application with different air volumes for heating and cooling

Description	Name	Default value
Supply air VAV maximum air volume flow for cooling	VavSuAirFI MaxC	100 [m <sup>3</sup> /h]
Supply air VAV minimum air volume flow for cooling	VavSuAirFI MinC	50 [m <sup>3</sup> /h]
Supply air VAV maximum air volume flow for heating	VavSuAirFI MaxH	100 [m <sup>3</sup> /h]
Supply air VAV minimum air volume flow for heating	VavSuAirFI MinH	50 [m <sup>3</sup> /h]
Supply air VAV minimum air flow for ventilation	VavSuAflMinVnt	0 [m <sup>3</sup> /h]

## 17.4 Air volume control

All explanation of volume flow control ignore air aftertreatment. In order words, the supply air sequences start directly at the room temperature setpoints and not only after air aftertreatment has reached maximum.

### Temperature control

Temperature control works with the actual room temperature setpoints for the actual operating mode and calculates a set volume flow that moves between the minimum and maximum setpoints.

The minimum and maximum air volume flows for a VAV actuator can be configured for each actuator.

### Air quality control

The VAV application can be used for air quality control. The room must have an air quality sensor. The application automatically enables air quality control as soon as an air quality sensor is configured.



Air quality setpoints can be configured separately for each room operating mode.

Description	Name	Default value
Room air quality setpoint for Comfort	SpAQualRCmf	900 ppm
Room air quality setpoint for Pre-Comfort	SpAQualRPcf	1100 ppm
Room air quality setpoint for Economy	SpAQualREco	1500 ppm
Room air quality setpoint for Protection	SpAQualRPrt	1500 ppm

The minimum and maximum air volume flows for a VAV actuator can be configured for each actuator.

Description	Name	Default value
Supply air VAV maximum air flow for ventilation	VavSuAflMaxVnt	100 [m <sup>3</sup> /h] 27.78 [l/s]
Supply air VAV minimum air flow for ventilation	VavSuAflMinVnt	0 [m <sup>3</sup> /h] 0.00 [l/s]

## Air flow tracking

Air volume tracking can be configured on the VAV application if supply air VAV and extract air VFAV is used in a room. You can also define how much positive or negative pressure can be created in the room.

In the room, parameter AirFITrn distinguishes between the extract air volume flow setpoint from the supply air volume flow setpoint.

Description	Name	Default value
Room air operating mode 1:Neutral 2:Positive pressure 3:Negative pressure	PRMod	1:Neutral
Overflow air volume flow	AirFITrn	10 m <sup>3</sup> /h 2.77 l/s

For example: In a room with negative pressure, the extract air volume setpoint = 500, for supply air = 600 and AirFITrn = 100. In a room with positive pressure, the extract air volume setpoint = 700, for supply air = 600 and AirFITrn = 100.

### 17.4.1 External volume air flow control

A differential pressure sensor is typically connected to the VAV actuator for an application with external volume flow control. Which in turns also implements volume flow control. In this case, the application in the DXR2 controls only the room temperature and forwards the setpoint for volume flow control to the VAV actuator.

The present damper position is determined in all cases by DXR2 and provided to the central function for optimizing the supply air fan.

### 17.4.2 Internal volume flow control

A differential pressure sensor is typically connected to the DXR2 for an application with internal volume flow control. It can be implemented using the integrated pressure sensor on the DXR2 or an analog sensor. DXR2 then also operate volume flow control in addition to temperature control.

The present damper position is determined in all cases by DXR2 and provided to the central function for optimizing the supply air fan.

## 17.5 Parallel supply air VAV or extract air VAV

A maximum of one room can be configured on each DXR2. The room can consist of a maximum of one supply air and extract air VAV. You must create a multisegment application with multiple DXR2 automation stations if you need to use multiple VAV for supply or extract air. Any combination of supply air and extract air VAV can be created with DXR2. The VAV can even have various sizes and nominal air volume flows.

The standardized room control with controller signals 0...100% always controls all connected VAV actuators for supply and extract air as per their nominal volume flow and provide the correct amount of volume flow..

Room control attempts to compensate for a loss of a VAV actuator by using operational VAV to provide the missing volume flow.

## 17.6 Outputs

At the VAV outputs, KNX PL-Link VAV actuators, analog VAV actuators, analog damper actuators (with supplemental differential pressure sensor) or 3-position damper actuators (with supplemental differential pressure sensor) via Triac outputs.

## 17.7 Switch-off delay

The switch off of a fan is delayed for a specific period on applications that have electric heating coils/reheaters. This cools down the electric heating coils/reheater with circulating air. The switch-on/switch-off time can be configured.

Description	Name	Default value
Switch-off delay holding signal for air volume flow heating	DlyOffAflHldH	30 [s]

## 17.8 Return air sensor

The volume air flow must be available if room temperature measurement is made using a return air sensor in the VAV system, to correctly acquire the actual room temperature. A minimum air volume is enabled in the dead zone by default for the operating mode Comfort on the DXR2. The parameter cannot be changed when using a return air sensor to measure room temperature.

In this case, note that a conventional room temperature sensor must be configured at the DXR2 input. The return are temperature sensor is then connected instead of the room temperature sensor. The room is now temperature controlled per the measured value from the return air sensor.

DXR2 does not support interval-type air volume to periodically measure room temperature with the return air sensor.

Also note that DXR2 temperature control in the room can only have one measured return (temperature sensor) which is always configured and connected at the input of the room temperature sensor. The available configuration for a return air sensor is used for visualization on DXR2.

## 17.9 Locked by electric heating coils

Locking is a binary signal to protect VAV equipment. The application locks electric heating coils even if no air flow is available through the fan. Or enabled if air flow is available through the fan.

## 17.10 Start of air volume flow by heating demand

Volume flow is started for active heat or refrigeration demand in the room. The signal is sent to the fan from the heat or refrigeration register.

Description	Name
Display of heat/cooling request in the room. It starts the fan to meet the heat request.	AirFIHReq

## 17.11 Water register for 4-pipe system

Plant diagram

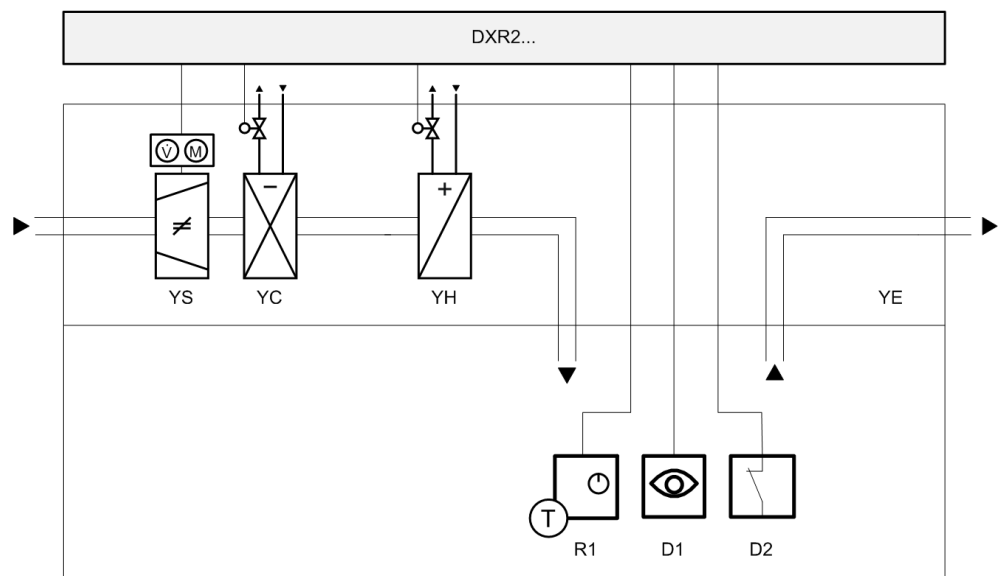

Figure: 4-pipe system VAV applications

Key:

DXR2...	Room automation station	R1	Room operator unit
YS	Supply air VAV	D1	Presence
YC	Chilled water cooling coils	D2	Window contact
YH	Hot water heating coils		

Sequences

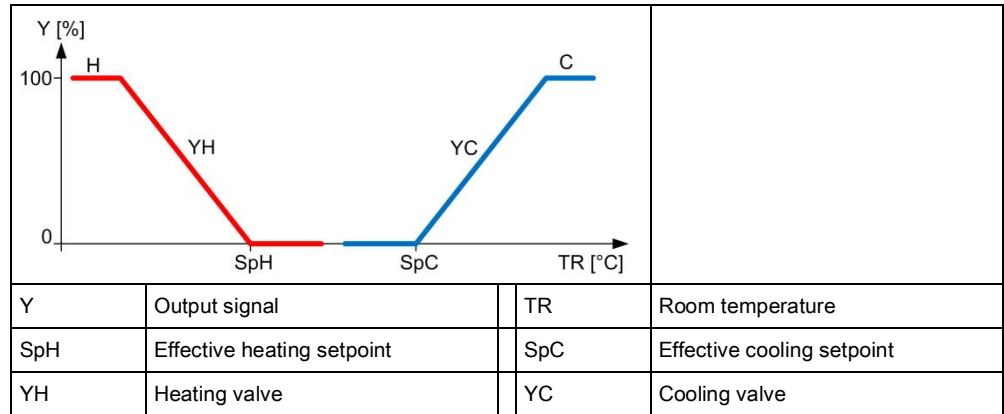

Figure: Modulating heating and cooling sequence

## 17.12 Water register 2-pipe system with changeover

Plant diagram

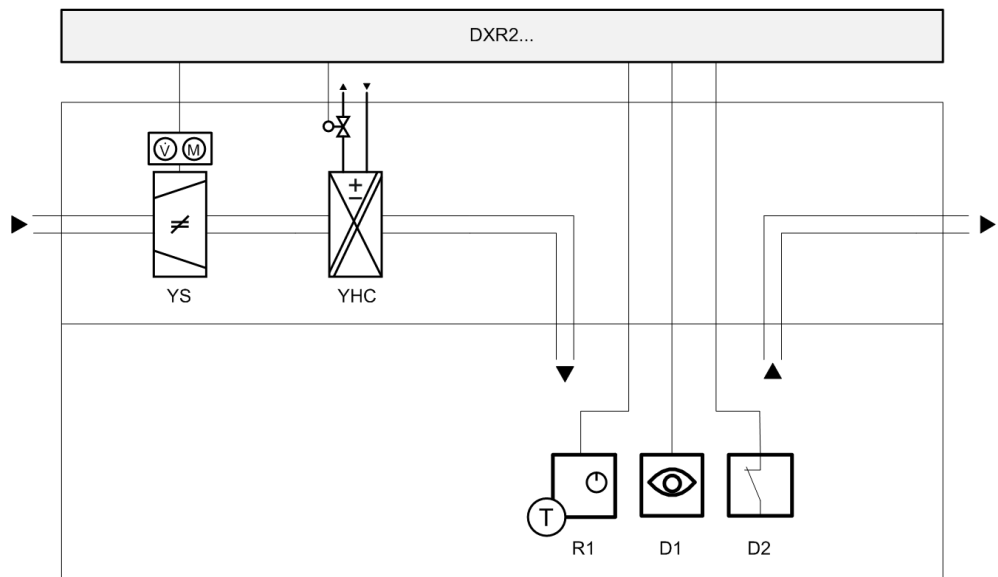

Figure: 2-pipe system VAV applications, with changeover

Key:

DXR2...	Room automation station	R1	Room operator unit
YS	Supply air VAV	D1	Presence
YHC	Heating/cooling coils	D2	Window contact

Sequences

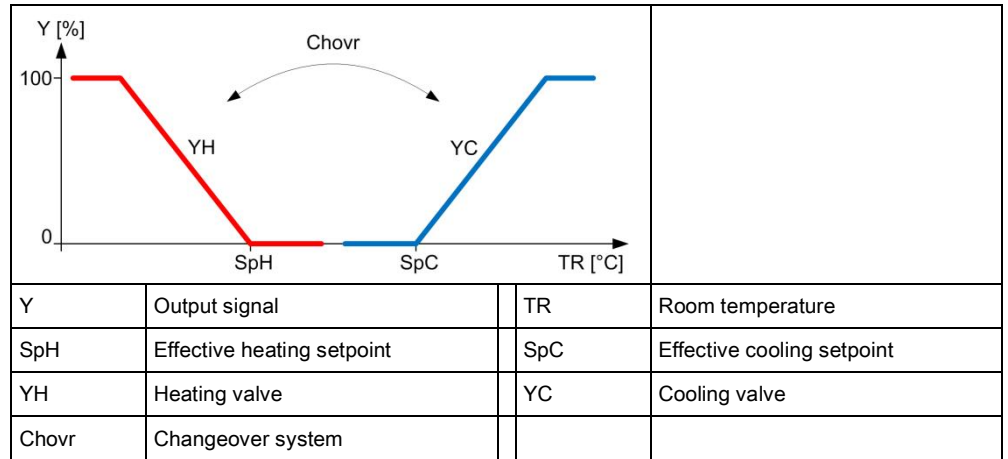

Figure: Modulating heating and cooling sequence with changeover system

### 17.13 Water register for 4-pipe system with changeover valves

Plant diagram

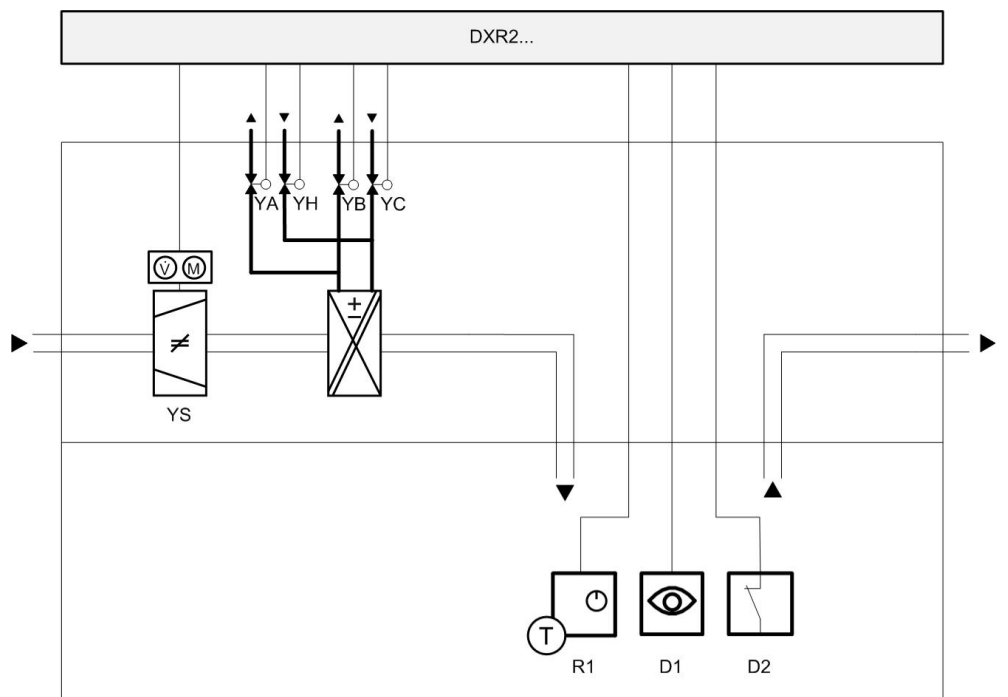

Figure: Example of water register 4-pipe system with changeover valves

Key:

DXR2...	Room automation station	R1	Room operator unit
YH	Heating valve	D1	Presence
YA	Changeover valve heating	D2	Window contact
YC	Cooling valve	YS	Supply air VAV

Sequences

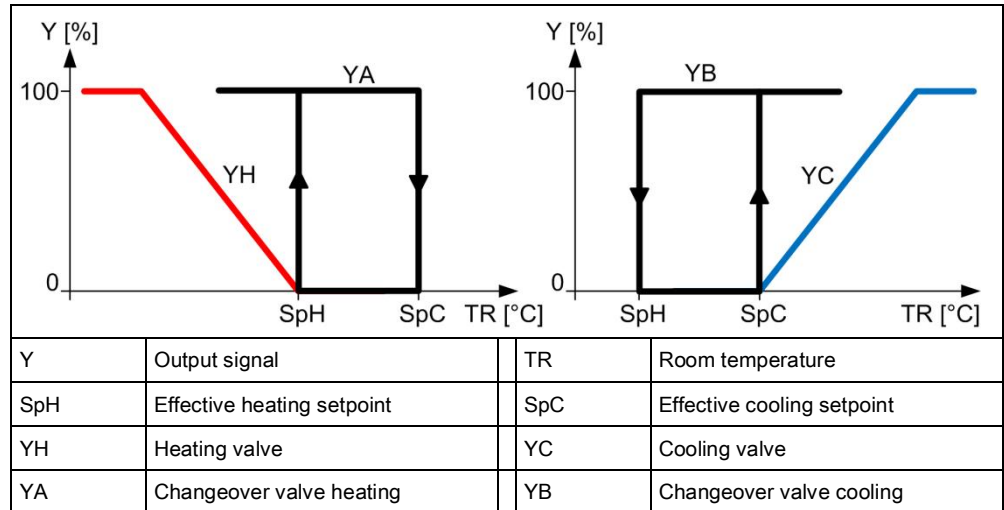

Figure: Modulating heating and cooling sequence

### 17.14 Water register 4-pipe system with 6-port valve

Plant diagram

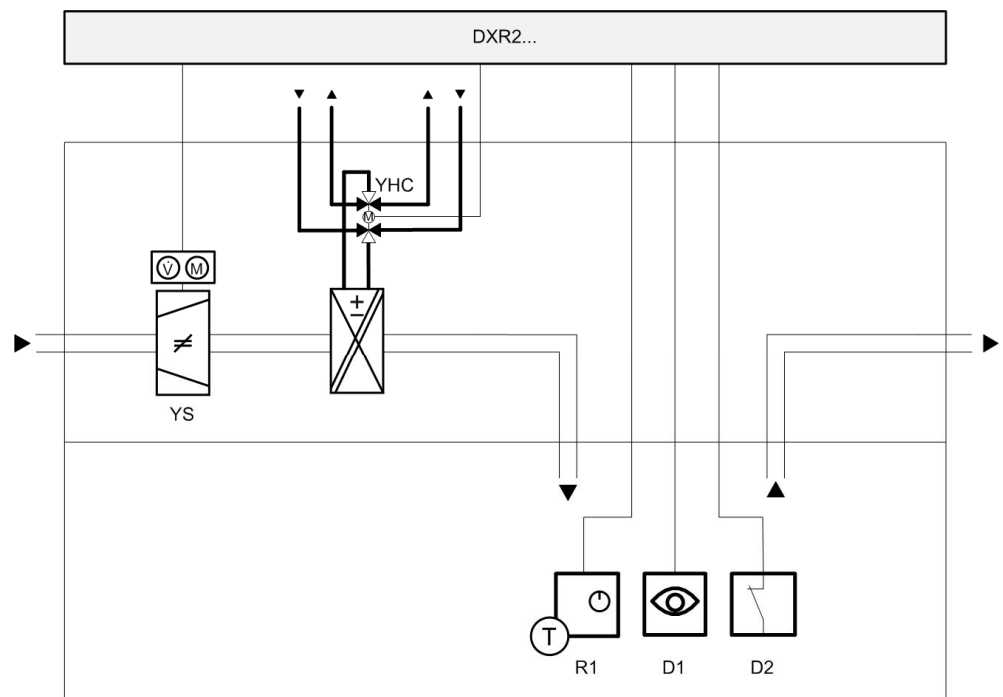

Figure: Example for 4-pipe system VAV applications with a 6-port valve

Key:

DXR2...	Room automation station	R1	Room operator unit
YHC	6-port valve	D1	Presence
		D2	Window contact

Sequences

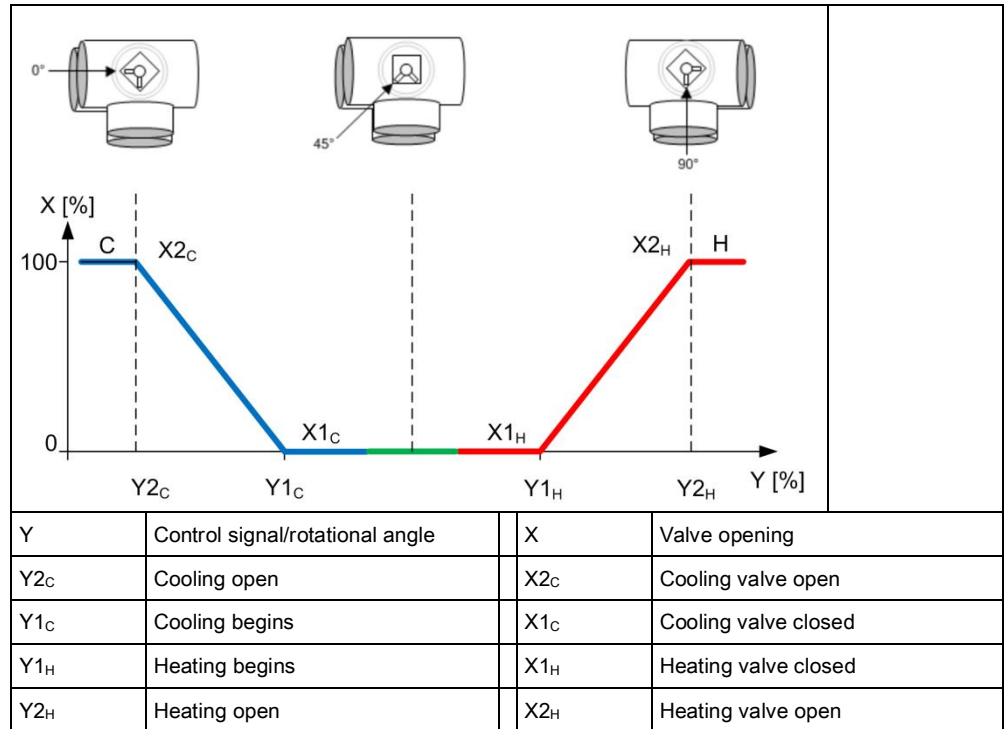

Figure: Modulating heating and cooling sequence with 6-port valve positions

Parameter settings

Description	Name	Default value
Cooling coil valve position X1c	X1CcVlvPos	0 [%]
Cooling coil valve position Y1c	Y1CcVlvPos	50 [%]
Cooling coil valve position X2c	X2CcVlvPos	100 [%]
Cooling coil valve position Y2c	Y2CcVlvPos	0 [%]
Heating coil valve position X1h	X1HcVlvPos	0 [%]
Heating coil valve position Y1h	Y1HcVlvPos	50 [%]
Heating coil valve position X2h	X2HcVlvPos	100 [%]
Heating coil valve position Y2h	Y2HcVlvPos	100 [%]

## 17.15 Water register 2-pipe system, cooling only

### Plant diagram

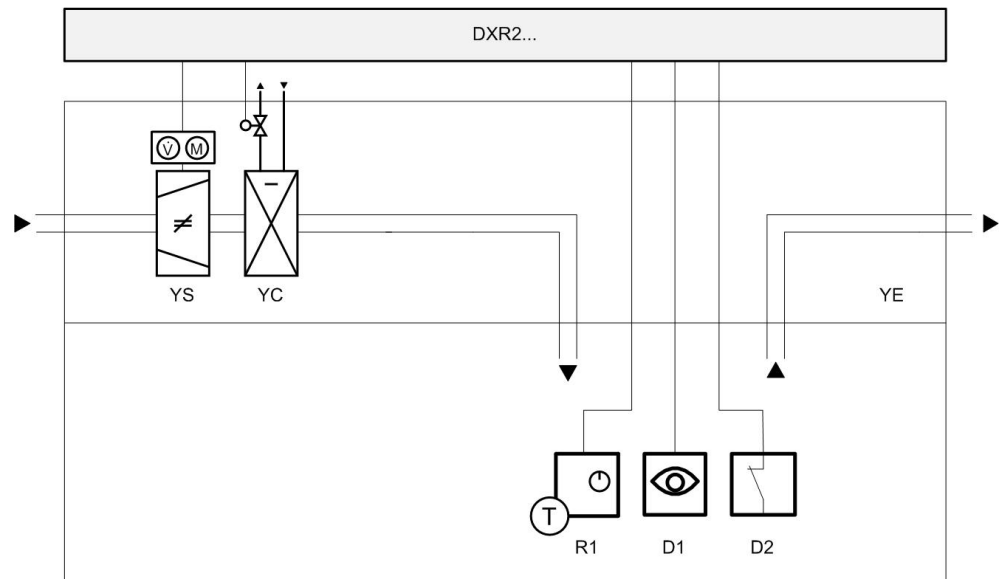

Figure: 2-pipe system VAV applications, cooling only

Key:

DXR2...	Room automation station	R1	Room operator unit
YS	Supply air VAV	D1	Presence
YC	Chilled water cooling coils	D2	Window contact

### Sequences

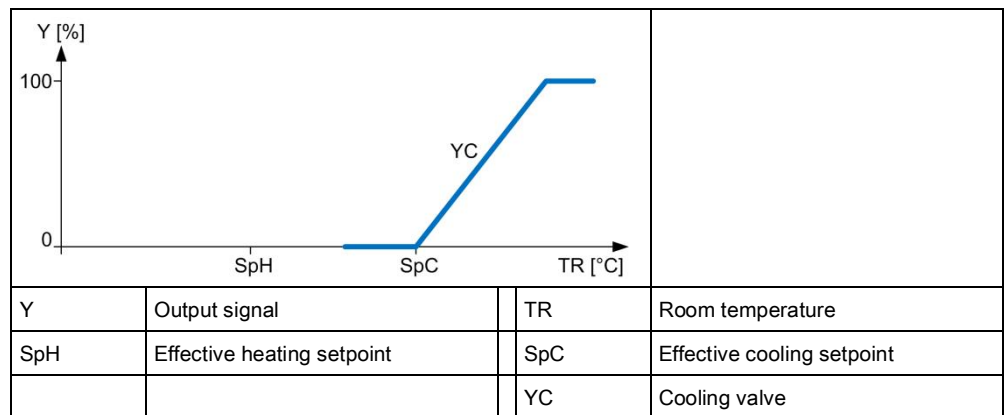

Figure: Modulating cooling sequence



## 17.16 Water register 2-pipe system, heating only

Plant diagram

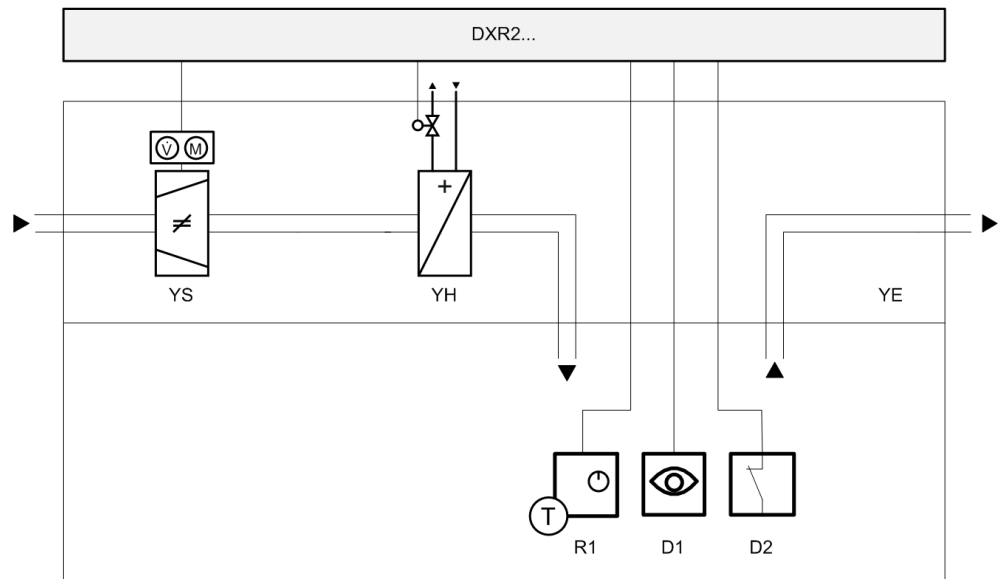

Figure: 2-pipe system VAV applications, heating only

Key:

DXR2...	Room automation station	R1	Room operator unit
YS	Supply air VAV	D1	Presence
YH	Hot water heating coils	D2	Window contact

Sequences

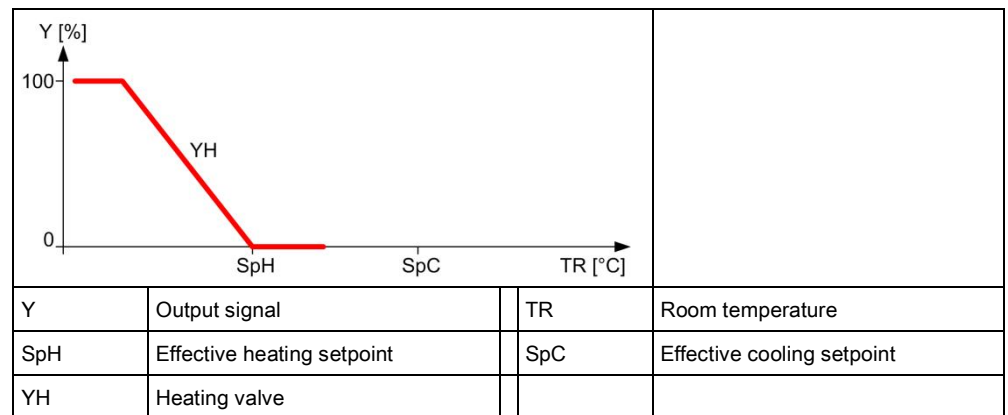

Figure: Modulating heating sequence

## 17.17 Actuators

The DRX2 automation station controls heating/cooling valves via Triac and analog outputs, regardless of available I/Os. 3-position actuators, thermal pulse width modulation (PWM) actuators, PWM actuators with return spring can be connected to the Triac outputs.

A maximum of 1 thermal valve can be connected to each Triac on the DXR2 automation station with AC 230 V power.

Conventional 0...10V actuators as well as 6-port valves can be connected to analog outputs.

## 17.18 Valve protection

Valve actuators are operated from time to time to prevent them from seizing after long periods of inactivity (e.g. heating valve during the summer). The valve actuator is controlled to lose as little heating energy as possible.

The central function for the hot water supply chain performs the valve protection function and can be changed in the parameters as needed.

Description	Name	Default value
Kick value	KickVal	50 [%]
Kick time	TiKick	2 min
Kick cycle	KickCyc	500 h

## 17.19 Determination of heating/cooling state

All DXR2 applications analyze heating/cooling state by comparing the present room temperature against the setpoints and active control sequence. The present state is displayed on the room operator unit and the BAC system.

A sequence controller prevent simultaneous heating/cooling.

## 17.20 Heating/cooling demand

Each DXR2 automation station calculates heating and cooling demand for a room and makes the result available through a group of the central function (supply chain hot water/chilled water).

### Outside air temperature dependent heating curve

The hot water demand setpoint is calculated in the central function using a heating curve based on the outside temperature.

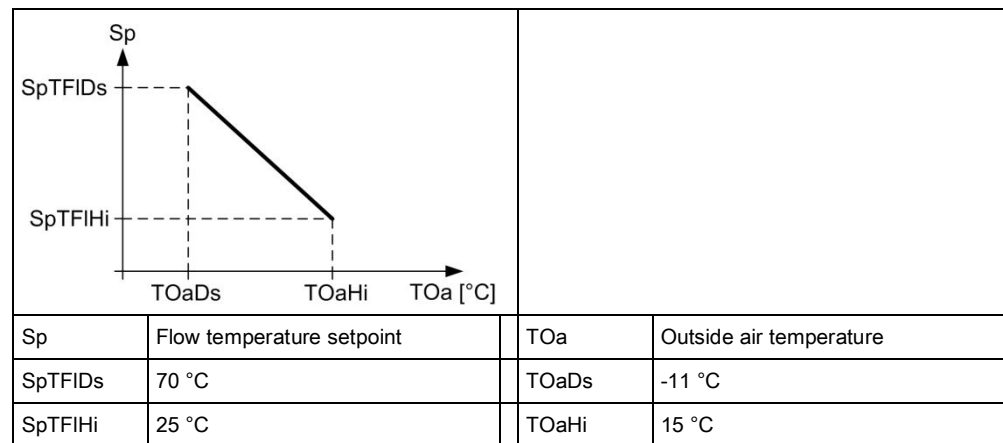

**Figure: Characteristic curve for the outside temperature-dependent heating curve**

### Demand correction by collected valve positions

Valve positions in the various rooms correct the demand setpoint in the central function based on the number of valves between a value of 70...100%.

Description	Name	Default value
Setpoint correction, if 100% of all consumers are within 70...100%.	SpCorrTFIHi	5 [K]
Setpoint correction, if 0% of all consumers are within 70...100%.	SpCorrTFILo	-5 [K]

## 17.21 Preheating

The central functions can trigger the preheating function to heat up a room at end of the night setback period as quickly as possible to the Pre-Comfort setpoint. This impacts the plant operating mode of the application.

## 17.22 Emergency operation

The setpoint for protection ensures that room temperatures do not change below or above a critical limit.

## 17.23 Reset setpoint

The central function can reset a local change to a setpoint on the room operator unit. The management station can manually reset the value or the reset can also be automatic by a scheduler. Setpoints for room temperature, ventilator stage, and room operating mode can be reset.

## 17.24 Free inputs/outputs

Inputs and outputs can be configured as free inputs on all DXR2s. This permits the querying of unused input and output switching states or directly controlling another device over BACnet.

## 17.25 Centrally override valves

Central functions permit the central override of all valve in the supply group. The following parameters can be used.

Description	Name	Default value
Enable valve position override	EnVlvPosOvrr	0:No 1:Yes
Valve position override	VlvPosOvrr	100 [%]

## 17.26 Electric heating coil

One electric heating coil can be configured for VAV applications. The DRX2 automation station controls electric heating coils via Triac or analog outputs, regardless of available I/Os. Single-stage, 2-stage, and modulating electric heating coils are supported.

### Plant diagram

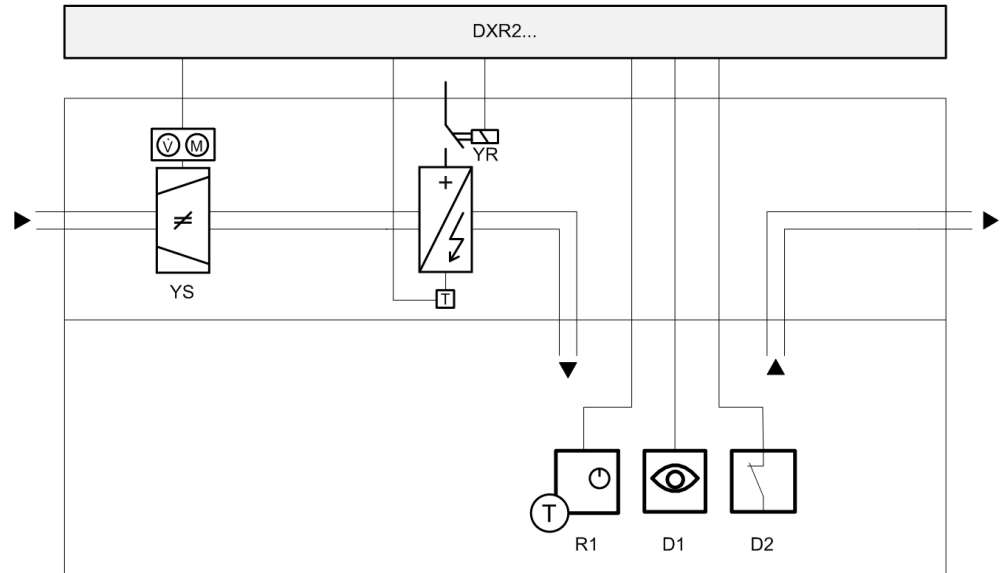

Figure: Example of a VAV application with electric heating coils

Key:

DXR2...	Room automation station	R1	Room operator unit
YS	Supply air VAV	D1	Presence
YR	Electric heating coil	D2	Window contact
T	Over temperature contact		

### Sequences

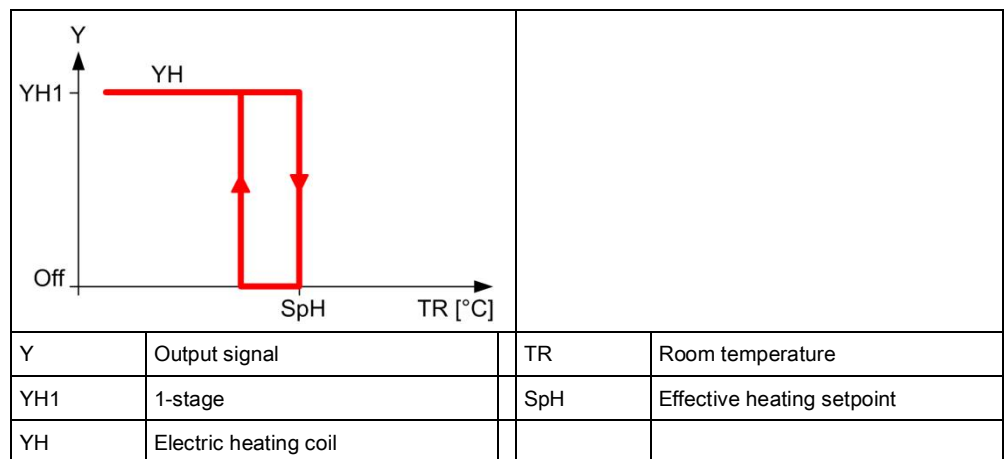

Figure: 1-stage electric heating coils

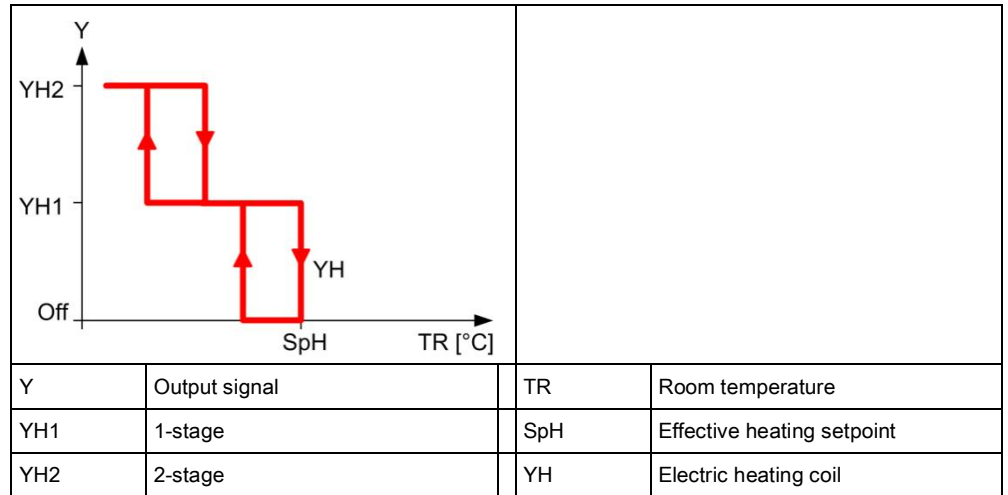

Figure: 2-stage electric heating coils

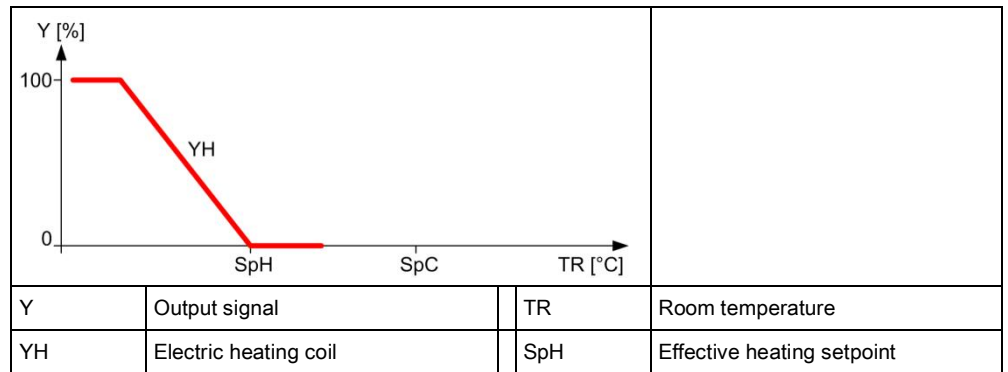

Figure: Modulating electric heating coils

**Actuators**

Electric heating coils, controlled via an analog output on the DXR2, can receive an enable via a relay or Triac on the DXR2. A binary overtemperature protection can be connected on the DXR2 for all versions of the electric heating coils application.

**Safety thermostat**

A binary overtemperature (open contact) protection can be connected on the DXR2 for all versions of the electric heating coil application. The application switches off the electric heating coils at device protection priority if overtemperature protection is enabled.

Description	Name	Default value
Enable overtemperature input 0:No 1:Yes	EnOvrTDetIn	0:No

## 17.27 Electric reheater

DXR2 applications permit control of electric heating coils, in addition to control of water heating valves and/or heating/chilled water valves. They are then operated as reheaters and only enabled if the water heating valve is fully open.

### Plant diagram

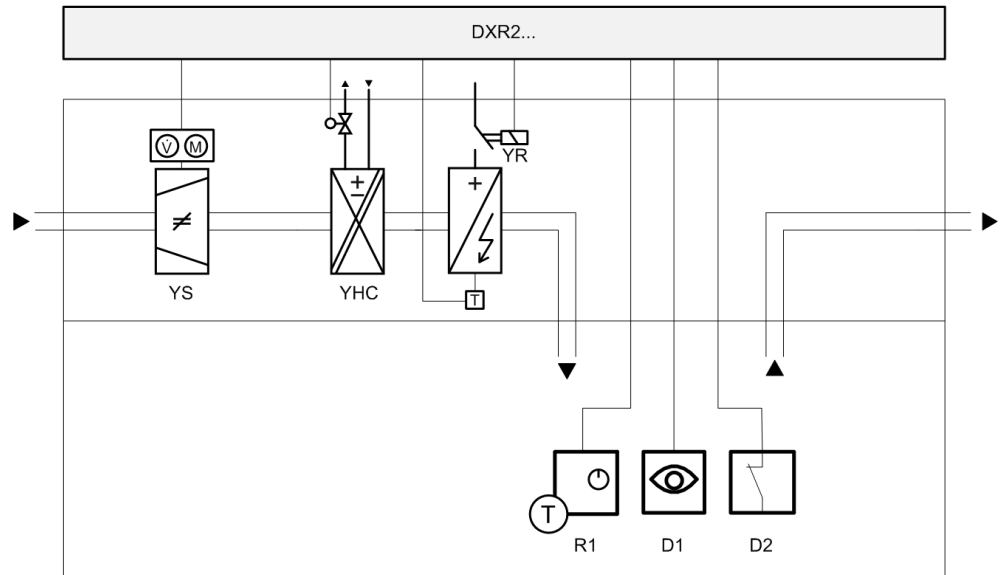

Figure: Example for a 2-pipe system VAV application with electric reheater

Key:

DXR2...	Room automation station	R1	Room operator unit
YS	Supply air VAV	D1	Presence
YHC	Heating/cooling coils	D2	Window contact
YR	Electric reheater	T	Over temperature contact

### Sequences

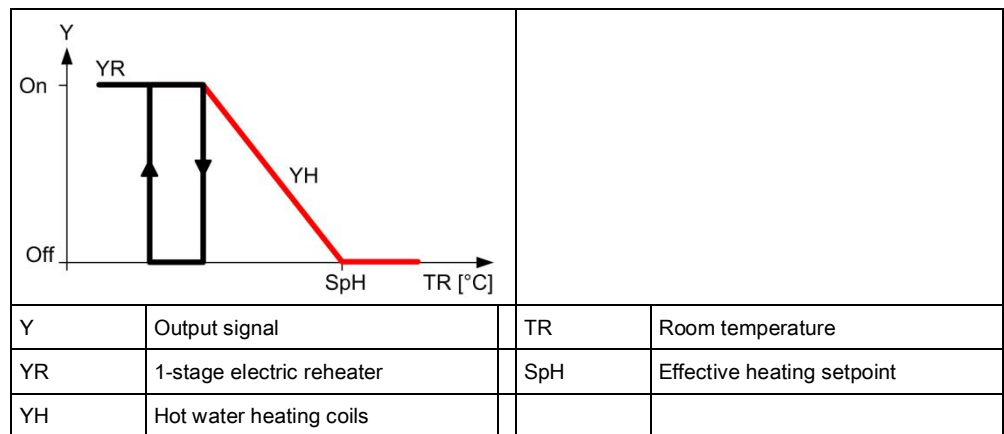

Figure: 1-stage electric reheater

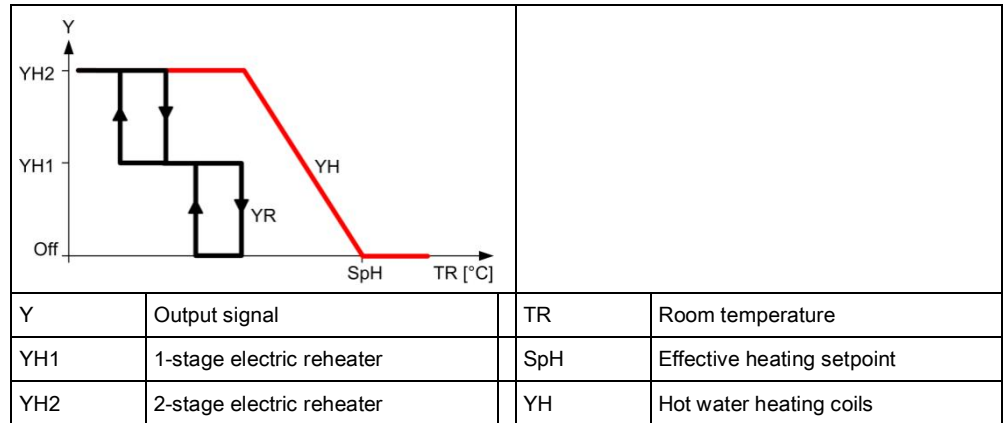

Figure: 2-stage electric reheater

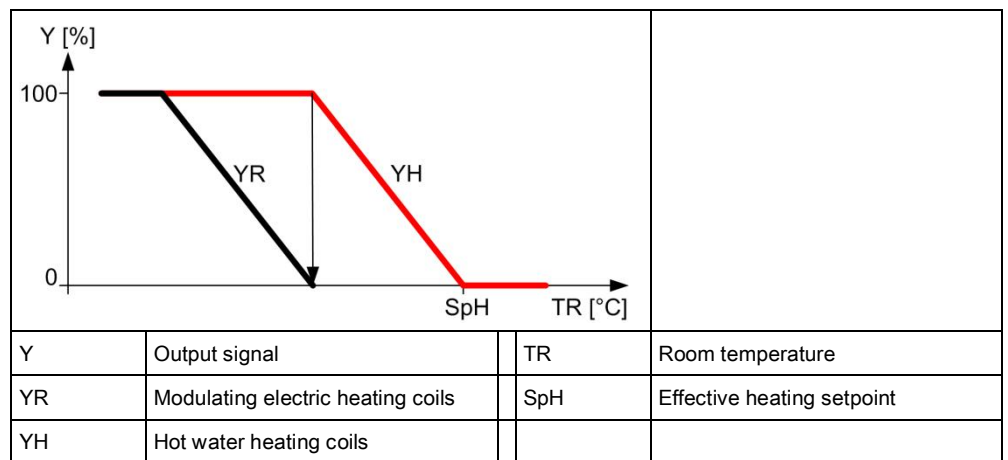

Figure: Modulating electric reheater

**Actuators**

Electric heating coils, controlled via an analog output on the DXR2, can receive an enable via a relay or Triac on the DXR2. A binary overtemperature protection can be connected on the DXR2 for all versions of the electric heating coils application.

**Safety thermostat**

A binary overtemperature (open contact) protection can be connected on the DXR2 for all versions of the electric heating coils or electric reheaters. The application switches off the electric coils or electric reheaters at device protection priority if overtemperature protection is enabled.

Description	Name	Default value
Enable overtemperature input 0:No 1:Yes	EnOvrTDetIn	0:No

## 17.28 Night cooling

The plant operating mode cools a room using cooling outside air. The central function sends a "Night cooling request" to the group member rooms. The decision as to whether night cooling makes sense and is energy efficient is made at the central function. Various coordination signals between the primary plant and room automation do the following via central functions:

- Switch on the fans,
- Set the mixed air dampers to 100% outside air,
- Lock all other equipment including heating coils, cooling coils, humidifier.

Night cooling only occurs under the following conditions:

- The room is vacant (Economy or Protection).
- The outside temperature is above an adjustable setpoint of 9 °C.
- The temperature difference to cooling is sufficiently large, i.e. room temperature - outside temperature > 7 K.
- The temperature deviation from room temperature and temperature setpoint is sufficiently large, i.e. room temperature > room setpoint + 2 K.

Description	Name	Default value
Night cooling 0:Inactive 1:Active	NgtCReq	0:Inactive

## 17.29 Presence control

The HVAC application can also be controlled by presence through the use of a presence detector.

The HVAC application can be configured for each room to react to presence for each room and regardless of the room operating mode.

Description	Name	Default value
Presence operating mode for Comfort 1:None 2:Considered presence 3:Considered absence 4:Considered presence & absence	PscModCmf	4:Considered presence & absence
Presence operating mode Pre-Comfort	PscModPcf	4:Considered presence & absence
Presence operating mode for Economy	PscModEco	1:None
Present operating mode for Protection	PscModPrt	1:None

The applicable delays for the HVAC application in a room can also be configured for each room.

Description	Name	Default value
Switching delay for presence	SwiDlyPrst	5 Min
Switching delay for absence	SwiDlyAbst	5 Min



## 17.30 Static calibration

Under static calibration, the values are configured in the application function from the data sheet on the VAV box. Per channel (supply air or extract air), enter two values: Volume flow in m<sup>3</sup>/h and the associated box coefficient c.

$$c = \frac{\dot{V}}{\sqrt{\Delta p}}$$

Description	Name	Default value
Nominal air volume flow	AirFINom	100 [m <sup>3</sup> /h]
Supply air VAV box coefficient	VavSuBoxCoef	150 [m <sup>3</sup> /hSqrtPa]

## 17.31 Dynamic calibration

Dynamic calibration can be only conducted during operation with a network and switched-on VAV system.

The DXR2 web server during commissioning is used to conduct dynamic calibration of a VAV box. The DXR2 web server must be connected. After logging on, the user is provided a Favorites view for calibration. The overview includes all relevant parameters and the data point for automatically conducting dynamic calibration. The following list displays an overview of the parameters on dynamic calibration for each VAV box.

A detailed guide on dynamic calibration and a video guide is available from the Siemens download center [www.siemens.com/bt/download](http://www.siemens.com/bt/download).

Description	Name	Default value
Supply air VAV calibration command 0:Ready 1:Balancing 2:Calibrate 3:Record 4:Balanced	VavSuBalCmd	0:Ready
Supply air VAV balancing state	VavSuBalSta	1:Initial
Supply air VAV balancing operating mode 0:Maximum cooling 1:Maximum heating 2:Maximum ventilation 3:Minimum cooling 4:Minimum heating 5:Minimum ventilation 6:Manual	VavSuBalMod	0:Maximum cooling
Supply air flow hood	VavSuAirFIHood	100 [m <sup>3</sup> /h]
Supply air VAV recorded balancing operating mode 0:Maximum cooling 1:Maximum heating 2:Maximum ventilation 3:Minimum cooling 4:Minimum heating 5:Minimum ventilation 6:Manual	VavSuBalModRec	1:Maximum cooling
Supply air VAV recorded air flow hood	VavSuAflHodRec	0 [m <sup>3</sup> /h]
Supply air VAV recorded flow coefficient	VavSuFICoefRec	0
Supply air VAV initial flow coefficient	VavSuFICoefIni	0
Supply air VAV recorded air flow	VavSuAirFIRec	0 [m <sup>3</sup> /h]

Description	Name	Default value
Variable air flow supply air recorded position	VavSuPosRec	0 [%]
Supply air VAV duct surface area	VavSuDuctArea	0.05 [m <sup>2</sup> ]
Supply air VAV duct shape	VavSuDuctShape	2:Round
Supply air VVS dimension A	VavSuDmsnA	20 [cm]
Supply air VVS dimension B	VavSuDmsnB	20 [cm]
Supply air VAV flow coefficient	VavSuFICoef	0.78
Supply air VAV smoke extraction air volume flow setpoint	VavSuSpAflSmk	50 [m <sup>3</sup> /h]
Supply air VAV maximum air volume flow for cooling	VavSuAirFIMaxC	100 [m <sup>3</sup> /h]
Supply air VAV minimum air volume flow for cooling	VavSuAirFIMinC	50 [m <sup>3</sup> /h]
Supply air VAV maximum air volume flow for heating	VavSuAirFIMaxH	100 [m <sup>3</sup> /h]
Supply air VAV minimum air volume flow for heating	VavSuAirFIMinH	50 [m <sup>3</sup> /h]
Supply air VAV maximum air flow for ventilation	VavSuAflMaxVnt	100 [m <sup>3</sup> /h]
Supply air VAV minimum air flow for ventilation	VavSuAflMinVnt	0 [m <sup>3</sup> /h]

## 17.32 Application examples

These are the descriptions of HIT applications on <http://hit.sbt.siemens.com>.

Visit the Siemens Download Center [www.siemens.com/bt/download](http://www.siemens.com/bt/download) for the latest application configurations.

### 17.32.1 Variable air volume

VAV041	Supply and extract VAV with analog damper actuator, heating and cooling coil on triac output	A6V10662236	<a href="#">en</a> <a href="#">de</a>
VAV081	Supply and extract VAV with analog VAV controller, heating and cooling coil and hot water radiator on triac output	A6V10662238	<a href="#">en</a> <a href="#">de</a>
VAV082	Supply and extract VAV with KNX PL-Link VAV controller, heating and cooling coil and hot water radiator on triac output	A6V10662238	<a href="#">en</a> <a href="#">de</a>
INT151	Supply and extract VAV with KNX PL-Link VAV controller, heating and cooling coil, hot water radiator on triac output including lighting and blinds operation	A6V10662238	<a href="#">en</a> <a href="#">de</a>

## 18 Fan-Powered Box

The fan powered box (a fan-supported VAV box) with with two controlled air flows. The primary air is controlled with an air damper; the fan is speed controlled. The fan can be physically installed at two different locations: The serial fan and the parallel fan.

- The serial fan powered box transports the overall volume flow
- The parallel fan powered box transports only the recirculating portion

The fan powered box application can be configured using a FPB (Fan Powered Box) application type. Each FPB application type can also combine a radiant/chilled ceiling or radiator application. The image below provides an overview of the FFB application type with all possible HVAC components that can be configured for a FFB application. The configuration enabled the applicable (required) aggregate on the DXR2.

### Plant diagram

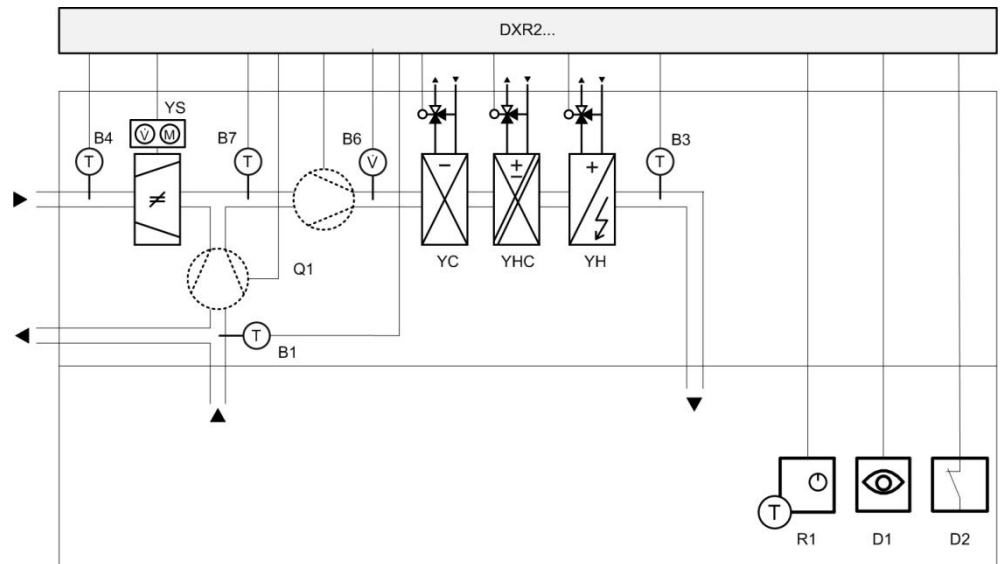

Figure: Application types for FPB applications

Key:

DXR2...	Room automation station	B4	Primary air temperature
B1	Return air temperature sensor	R1	Room operator unit
B3	Supply air sensor	D1	Presence
B6	Differential pressure sensor (supply air)	B7	Mixed air temperature sensor
YC	Chilled water cooling coils	D2	Window contact
YHC	Heating/cooling coils	YS	VAV supply air
YH	Hot water heating coils or electric heating coils	Q1	Serial or parallel fan

**Change from parallel to serial fan powered box**

The fan position must be configured in the application. The monitoring signal of the fan in the VAV is switched on and off:

Description	Name	Default value
Enable monitor fan state 0:No (parallel mode) 1:Yes (serial mode)	EnMonFanSta	0:No

**The serial fan powered box transports the overall volume flow**

In a serial FPB application, the supply air can be mixed from return and primary air (cooling).

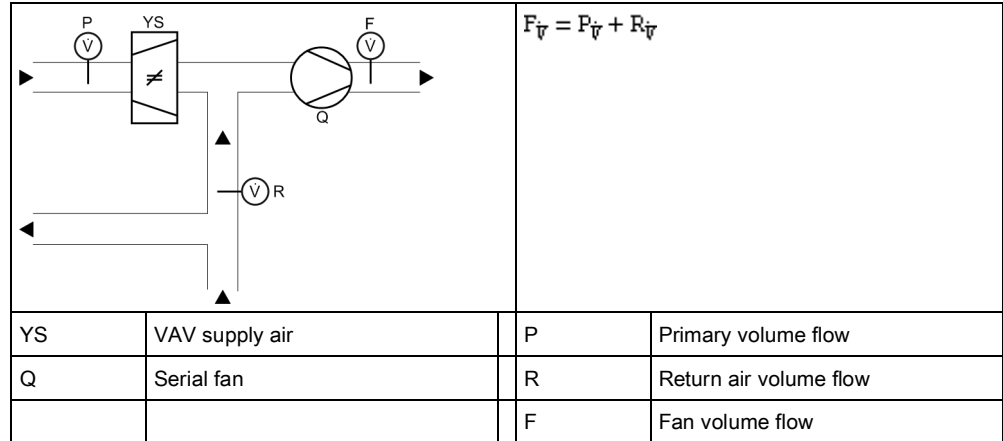

**Figure: Serial fan for a FPB application**

An application with serial fan must transfer the fan state to the VAV controller so that the VAV supplies only fresh air if the fan is also operating. This ensures that no fresh air enters the room via the return air duct. The following image is a diagram of the various locking and monitoring signals of a serial fan powered box applications.

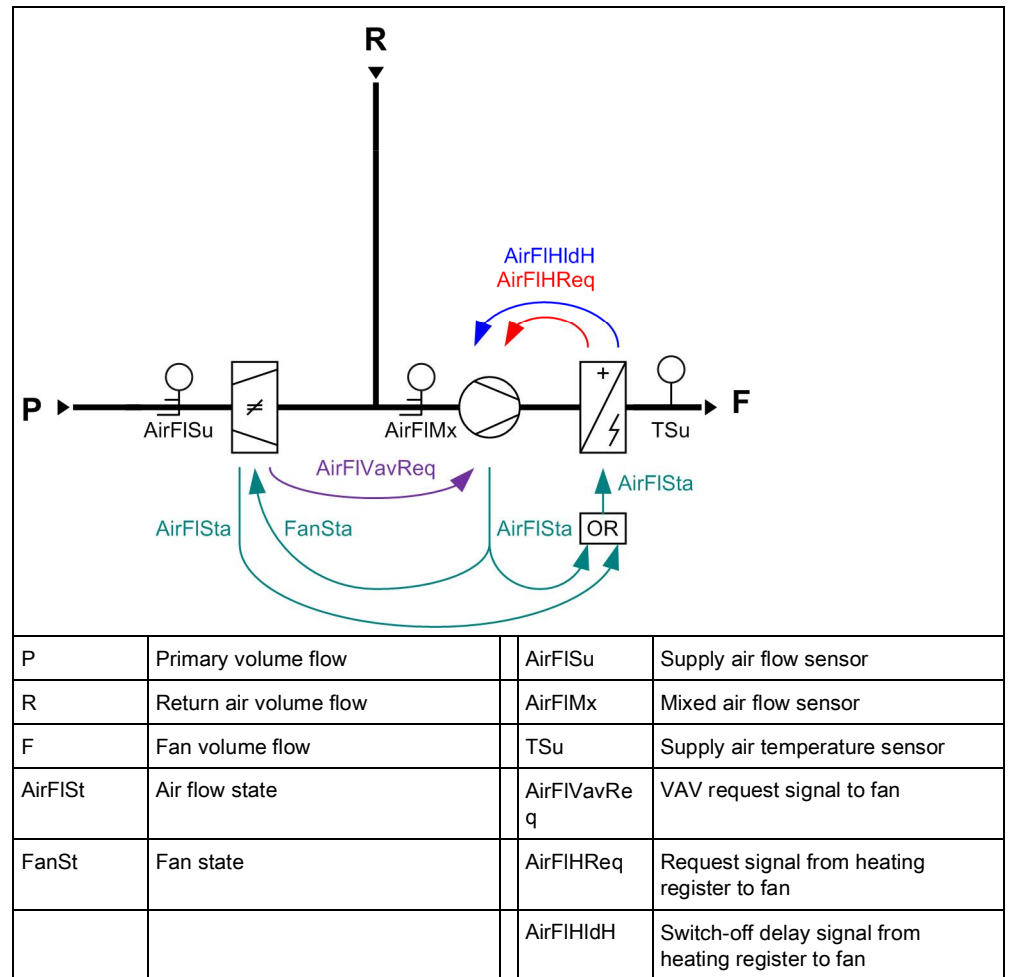
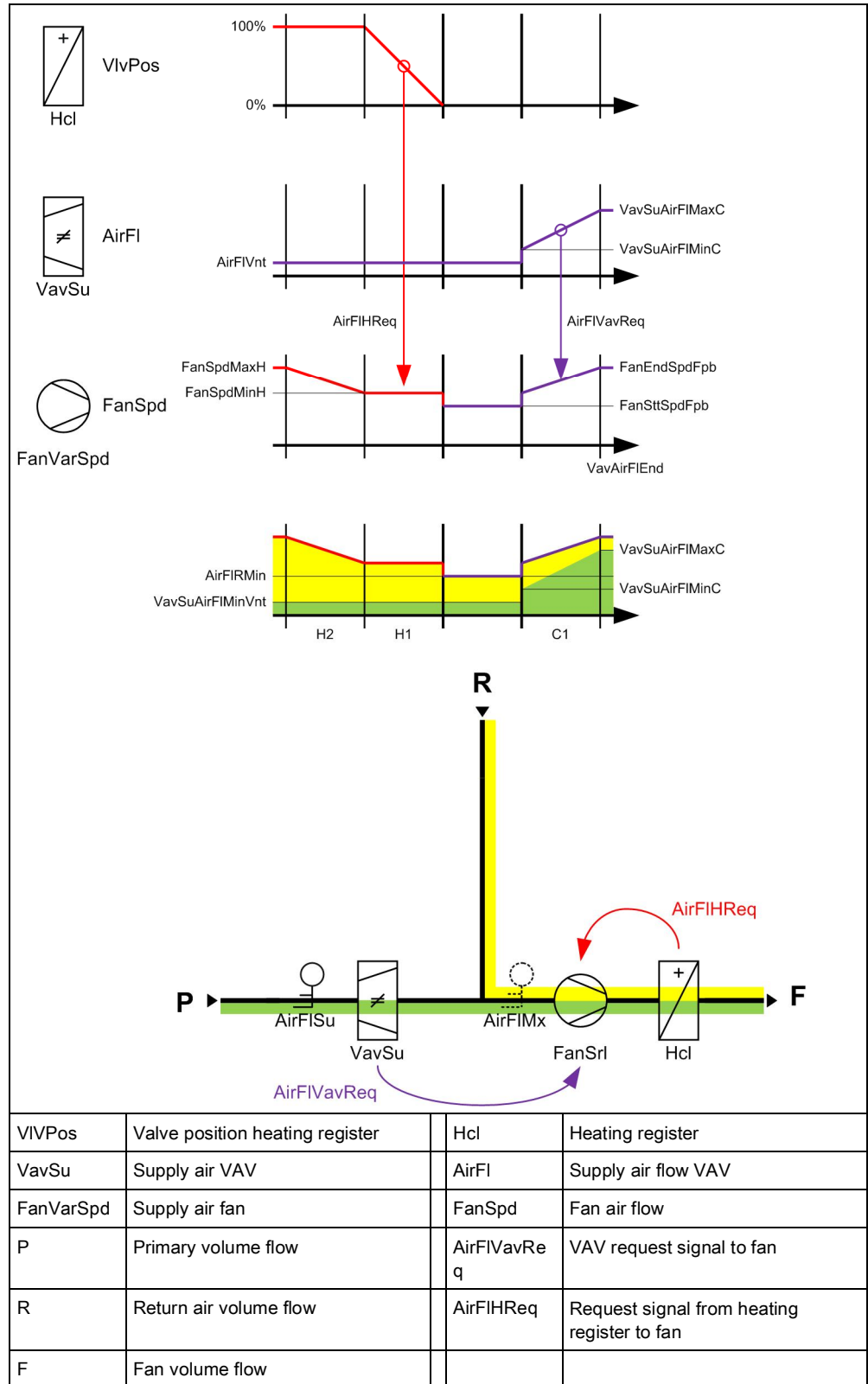

Figure: Serial FPB application

**Serial fan powered box control sequences**

The serial fan powered box control sequences are explained using the example with an auxiliary heating register. The associated setting parameters are explained in the following table that lists the preset values.



**Figure: Serial FPB application sequence**

Parameter settings

Description	Name	Default value
Supply air VAV maximum air volume flow for cooling	VavSuAirFIMaxC	100 [m³/h]
Supply air VAV minimum air volume flow for cooling	VavSuAirFIMinC	50 [m³/h]
Supply air VAV minimum air flow for ventilation	VavSuAflMinVnt	0 [m³/h]
Fan start speed at the fan powered VAV box	FanSttSpdFpb	50 [%]
Fan end speed at the fan powered VAV box	FanEndSpdFpb	100 [%]
Maximum fan speed heating	FanSpdMaxH	100 [%]
Minimum fan speed heating	FanSpdMinH	50 [%]

The parallel fan powered box transports the recirculating air portion

Supply air is typically not mixed in a parallel fan powered box application. There is either a primary (cooling) air flow by the central air flow system via the supply air damper or return air for general cooling and/or heating.

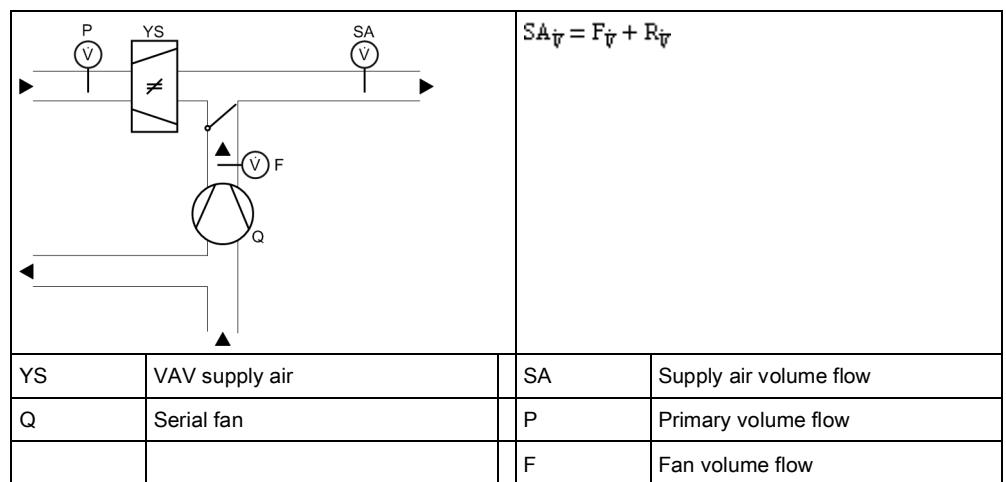

Figure: Parallel fan of a FPB application

The non-return damper ensures on an application with parallel fans, that no fresh air can enter the room via the return air duct.

The fan receives demand signals from the VAV box and the auxiliary heating register. The following image is a diagram of various locking and monitoring signals of a serial fan powered box application.

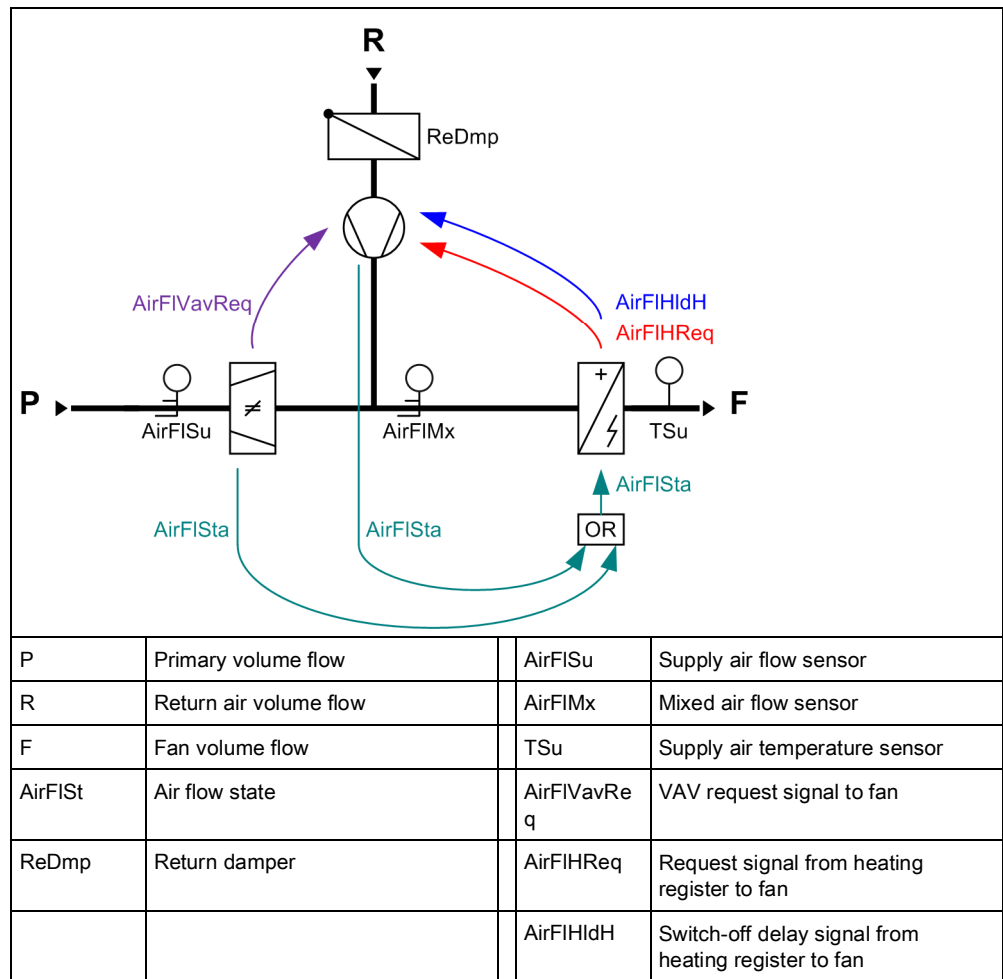
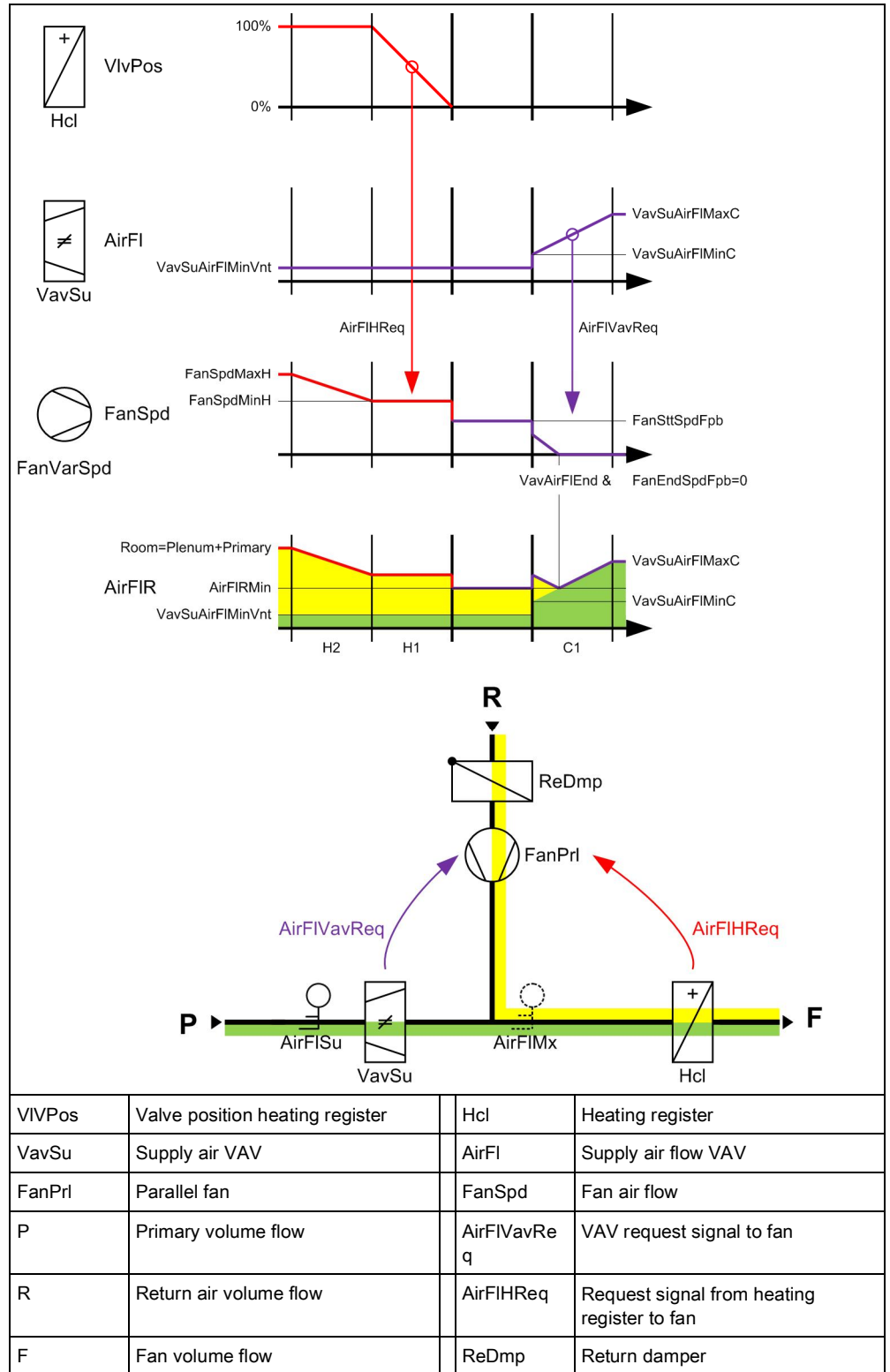

Figure: Parallel FPB application



**Serial fan powered box control sequences**

The serial fan powered box control sequences are explained using the example with an auxiliary heating register. The associated setting parameters are explained in the following table that lists the preset values.



**Figure: Serial FPB application sequence**

## Parameter settings

Description	Name	Default value
Supply air VAV maximum air volume flow for cooling	VavSuAirFIMaxC	100 [m <sup>3</sup> /h]
Supply air VAV minimum air volume flow for cooling	VavSuAirFIMinC	50 [m <sup>3</sup> /h]
Supply air VAV minimum air flow for ventilation	VavSuAflMinVnt	0 [m <sup>3</sup> /h]
Fan start speed at the fan powered VAV box	FanSttSpdFpb	50 [%]
Fan end speed at the fan powered VAV box	FanEndSpdFpb	100 [%]
Maximum fan speed heating	FanSpdMaxH	100 [%]
Minimum fan speed heating	FanSpdMinH	50 [%]

## 18.1 Serial or parallel control strategy for the fan

2 different control strategies can be selected for fan operation on the fan powered box application:

- Serial fan operation: The air volume is only increased if the valve's or reheater's positioning signal is fully open and the room temperature exceeds or breaches an additional offset.
- Parallel fan operation: The fan speed is increased in parallel to the valve's or repeater's positioning signal.

The two strategies are illustrates in the following example using a modulating fan and one heating and cooling valve. Both strategies can be used in the same manner for staged fans.

### Serial

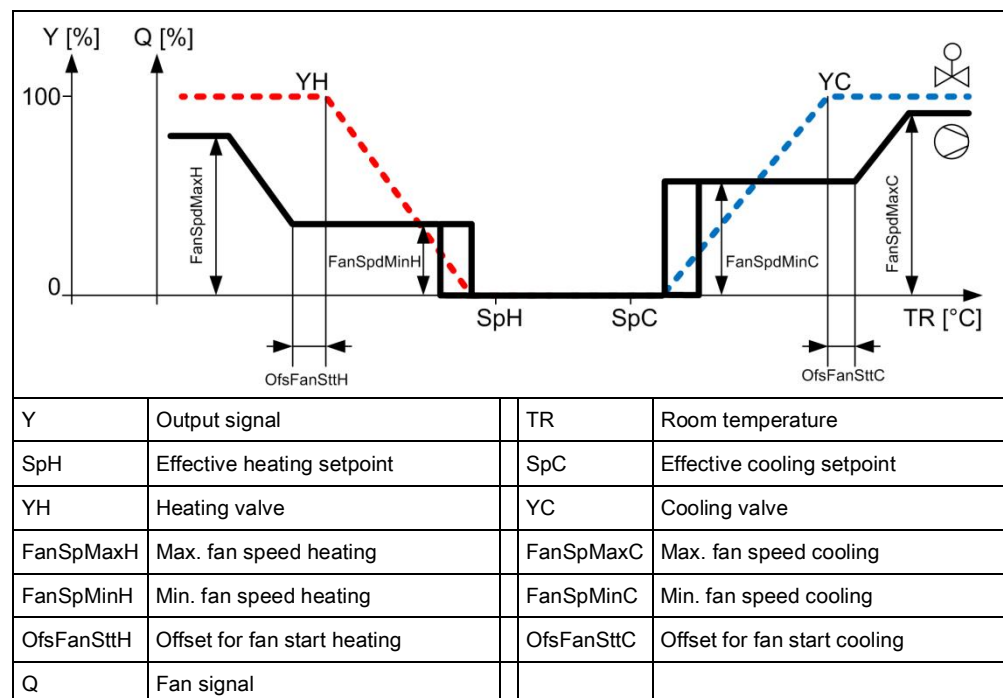

Figure: Example of a serial control strategy using a modulating fan

Parallel

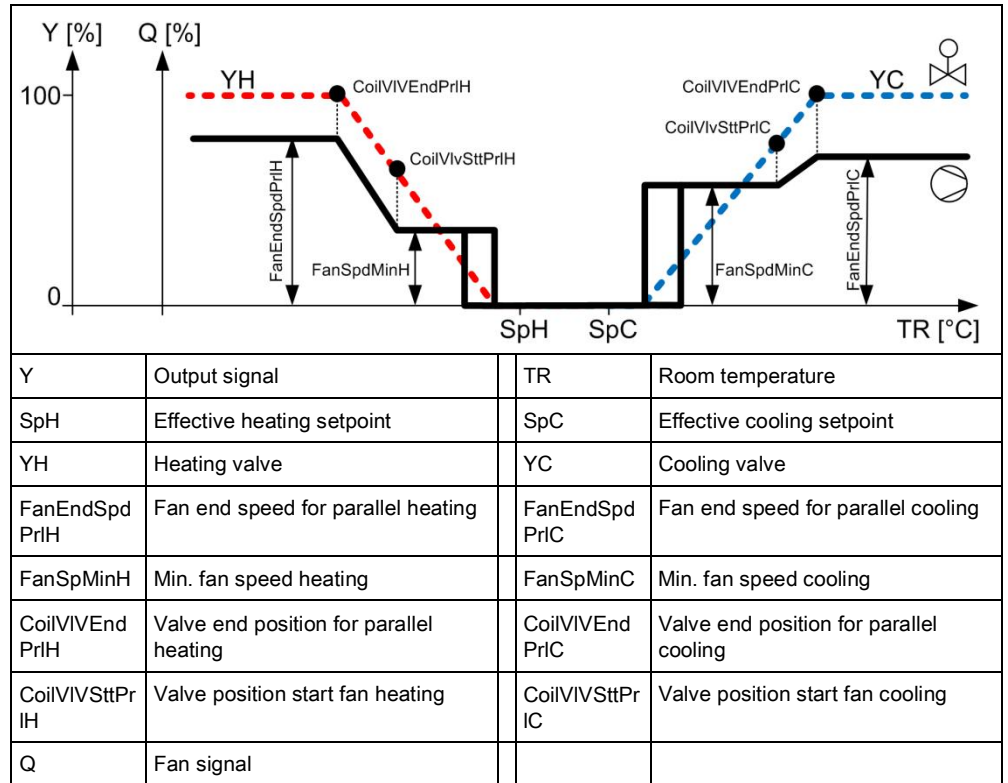

Figure: Example of a parallel control strategy using a modulating fan

The control strategy can be configured on the fan powered box application for the fan with the following parameters for the heating sequence.

Description	Name	Default value
Fan operation for cooling 0:Serial 1:Parallel	FanOp	1:Parallel
Fan operation for heating 0:Serial 1:Parallel	FanOp	1:Parallel

## 18.2 Air volume flow in the dead zone

The fan powered box application configures a minimum supply air flow in the temperature control dead zone. The function can be configured individually for all room operating mode.

Description	Name	Default value
Minimum supply air Comfort 1:Off 2:Minimum ventilation 3:Demand-controlled ventilation 4:Minimum ventilation & demand-controlled ventilation	CmfCnf	4:Minimum ventilation & demand-controlled ventilation
Minimum supply air for Pre-Comfort	PcfCnf	3:Demand-controlled ventilation
Minimum supply air Economy	EcoCnf	1:Off
Minimum supply air Protection	PrtCnf	1:Off

Minimum fan speed for all room operating modes is also configured. The two air flow specifications must be considered since the fan powered box application supplies the room in the VAV dead zone and the fan for the room.

Description	Name	Default value
Minimum fan speed for ventilation	FanSpdMinVnt	50 [%]
Supply air VAV minimum air flow for ventilation	VavSuAflMinVnt	0 [m <sup>3</sup> /h]

## 18.3 Air volume control

All explanation of volume flow control ignore air aftertreatment. In order words, the supply air sequences start directly at the room temperature setpoints and not only after air aftertreatment has reached maximum.

### Temperature control

Temperature control works with the actual room temperature setpoints for the actual operating mode and calculates a set volume flow that moves between the minimum and maximum setpoints.

The minimum and maximum air flow from a fan powered box can be individually configured.

### Air quality control

The FBP application can be used for air quality control. The room must have an air quality sensor. The application automatically enables air quality control as soon as an air quality sensor is configured.

Air quality setpoints can be configured separately for each room operating mode.

Description	Name	Default value
Room air quality setpoint for Comfort	SpAQualRCmf	900 ppm
Room air quality setpoint for Pre-Comfort	SpAQualRPcf	1100 ppm
Room air quality setpoint for Economy	SpAQualREco	1500 ppm
Room air quality setpoint for Protection	SpAQualRPrt	1500 ppm

The minimum and maximum air flow from a fan powered box can be individually configured. Note however, that a fan powered box of VAV and the fan supplies the room with air flow. So that both air flow specifications must be considered.

Description	Name	Default value
Supply air VAV maximum air flow for ventilation	VavSuAflMaxVnt	100 [m <sup>3</sup> /h] 27.78 [l/s]
Supply air VAV minimum air flow for ventilation	VavSuAflMinVnt	0 [m <sup>3</sup> /h] 0.00 [l/s]
Maximum fan speed for ventilation	FanSpdMaxVnt	100 [%]
Minimum fan speed for ventilation	FanSpdMinVnt	50 [%]

### 18.3.1 External volume air flow control

A differential pressure sensor is typically connected to the VAV actuator for an application with external volume flow control. Which in turns also implements volume flow control. In this case, the application in the DXR2 controls only the room temperature and forwards the setpoint for volume flow control to the VAV actuator.

The present damper position is determined in all cases by DXR2 and provided to the central function for optimizing the supply air fan.

### 18.3.2 Internal volume flow control

A differential pressure sensor is typically connected to the DXR2 for an application with internal volume flow control. It can be implemented using the integrated pressure sensor on the DXR2 or an analog sensor. DXR2 then also operate volume flow control in addition to temperature control.

The present damper position is determined in all cases by DXR2 and provided to the central function for optimizing the supply air fan.

## 18.4 Outputs

At the fan powered box outputs, KNX PL-Link VAV actuators, analog VAV actuators, analog damper actuators (with supplemental differential pressure sensor), or 3-position damper actuators (with supplemental differential pressure sensor) can be controlled via Triac outputs.

Analog outputs on the DXR2 control modulating fans.

## 18.5 Switch-off delay

The switch off of a fan is delayed for a specific period on applications that have electric heating coils/reheaters. This cools down the electric heating coils/reheater with circulating air. The switch-on/switch-off time can be configured.

Description	Name	Default value
Switch-off delay holding signal for air volume flow heating	DlyOffAflHldH	30 [s]

## 18.6 Return air sensor

The volume air flow must be available if room temperature measurement is made using a return air sensor in the FPB system, to correctly acquire the actual room temperature. A minimum air volume is enabled in the dead zone by default for the operating mode Comfort on the DXR2. The parameter cannot be changed when using a return air sensor to measure room temperature.

In this case, note that a conventional room temperature sensor must be configured at the DXR2 input. The return air temperature sensor is then connected instead of the room temperature sensor. The room is now temperature controlled per the measured value from the return air sensor.

DXR2 does not support interval-type air volume to periodically measure room temperature with the return air sensor.

Also note that DXR2 temperature control in the room can only have one measured return (temperature sensor) which is always configured and connected at the input of the room temperature sensor. The available configuration for a return air sensor is used for visualization on DXR2.

## 18.7 Locked by electric heating coils

Locking is a binary signal to protect FBP equipment. The application locks electric heating coils even if no air flow is available through the fan. Or enabled if air flow is available through the fan.

## 18.8 Start of air volume flow by heating demand

Volume flow is started for active heat or refrigeration demand in the room. The signal is sent to the fan from the heat or refrigeration register.

Description	Name
Display of heat/cooling request in the room. It starts the fan to meet the heat request.	AirFIHReq

## 18.9 Actuators

The DXR2 automation station controls heating/cooling valves via Triac and analog outputs, regardless of available I/Os. 3-position actuators, thermal pulse width modulation (PWM) actuators, PWM actuators with return spring can be connected to the Triac outputs.

A maximum of 1 thermal valve can be connected to each Triac on the DXR2 automation station with AC 230 V power.

Conventional 0...10V actuators as well as 6-port valves can be connected to analog outputs.

## 18.10 Valve protection

Valve actuators are operated from time to time to prevent them from seizing after long periods of inactivity (e.g. heating valve during the summer). The valve actuator is controlled to lose as little heating energy as possible.

The central function for the hot water supply chain performs the valve protection function and can be changed in the parameters as needed.

Description	Name	Default value
Kick value	KickVal	50 [%]
Kick time	TiKick	2 min
Kick cycle	KickCyc	500 h

## 18.11 Determination of heating/cooling state

All DXR2 applications analyze heating/cooling state by comparing the present room temperature against the setpoints and active control sequence. The present state is displayed on the room operator unit and the BAC system.

A sequence controller prevent simultaneous heating/cooling.

## 18.12 Heating/cooling demand

Each DXR2 automation station calculates heating and cooling demand for a room and makes the result available through a group of the central function (supply chain hot water/chilled water).

### Outside air temperature dependent heating curve

The hot water demand setpoint is calculated in the central function using a heating curve based on the outside temperature.

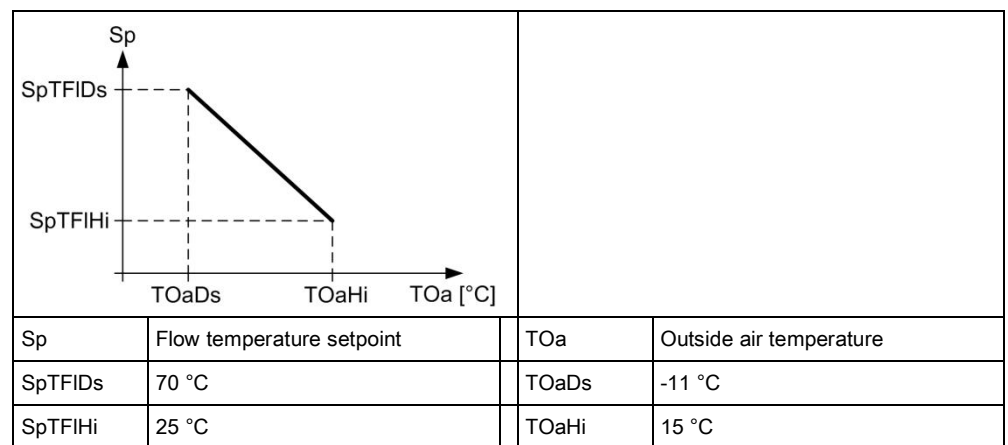

Figure: Characteristic curve for the outside temperature-dependent heating curve

### Demand correction by collected valve positions

Valve positions in the various rooms correct the demand setpoint in the central function based on the number of valves between a value of 70...100%.

Description	Name	Default value
Setpoint correction, if 100% of all consumers are within 70...100%.	SpCorrTFIHi	5 [K]
Setpoint correction, if 0% of all consumers are within 70...100%.	SpCorrTFILo	-5 [K]

## 18.13 Preheating

The central functions can trigger the preheating function to heat up a room at end of the night setback period as quickly as possible to the Pre-Comfort setpoint. This impacts the plant operating mode of the application.

## 18.14 Emergency operation

The setpoint for protection ensures that room temperatures do not change below or above a critical limit.

## 18.15 Reset setpoint

The central function can reset a local change to a setpoint on the room operator unit. The management station can manually reset the value or the reset can also be automatic by a scheduler. Setpoints for room temperature, ventilator stage, and room operating mode can be reset.

## 18.16 Free inputs/outputs

Inputs and outputs can be configured as free inputs on all DXR2s. This permits the querying of unused input and output switching states or directly controlling another device over BACnet.

## 18.17 Centrally override valves

Central functions permit the central override of all valve in the supply group. The following parameters can be used.

Description	Name	Default value
Enable valve position override	EnVlvPosOvrr	0:No 1:Yes
Valve position override	VlvPosOvrr	100 [%]

## 18.18 Electric reheater

Electric heating coils, controlled via an analog output on the DXR2, can receive an enable via a relay or Triac on the DXR2. A binary overtemperature protection can be connected on the DXR2 for all versions of the electric heating coils application.

### Safety thermostat

A binary overtemperature (open contact) protection can be connected on the DXR2 for all versions of the electric reheater application. The application switches off the electric reheater at device protection priority if overtemperature protection is enabled.

Description	Name	Default value
Enable overtemperature input 0:No 1:Yes	EnOvrTDetIn	0:No



## 18.19 Night cooling

The plant operating mode cools a room using cooling outside air. The central function sends a "Night cooling request" to the group member rooms. The decision as to whether night cooling makes sense and is energy efficient is made at the central function. Various coordination signals between the primary plant and room automation do the following via central functions:

- Switch on the fans,
- Set the mixed air dampers to 100% outside air,
- Lock all other equipment including heating coils, cooling coils, humidifier.

Night cooling only occurs under the following conditions:

- The room is vacant (Economy or Protection).
- The outside temperature is above an adjustable setpoint of 9 °C.
- The temperature difference to cooling is sufficiently large, i.e. room temperature - outside temperature > 7 K.
- The temperature deviation from room temperature and temperature setpoint is sufficiently large, i.e. room temperature > room setpoint + 2 K.

Description	Name	Default value
Night cooling 0:Inactive 1:Active	NgtCReq	0:Inactive

## 18.20 Presence control

The HVAC application can also be controlled by presence through the use of a presence detector.

The HVAC application can be configured for each room to react to presence for each room and regardless of the room operating mode.

Description	Name	Default value
Presence operating mode for Comfort 1:None 2:Considered presence 3:Considered absence 4:Considered presence & absence	PscModCmf	4:Considered presence & absence
Presence operating mode Pre-Comfort	PscModPcf	4:Considered presence & absence
Presence operating mode for Economy	PscModEco	1:None
Present operating mode for Protection	PscModPrt	1:None

The applicable delays for the HVAC application in a room can also be configured for each room.

Description	Name	Default value
Switching delay for presence	SwiDlyPrst	5 Min
Switching delay for absence	SwiDlyAbst	5 Min

## 18.21 Application examples

These are the descriptions of HIT applications on <http://hit.sbt.siemens.com>.

Visit the Siemens Download Center [www.siemens.com/bt/download](http://www.siemens.com/bt/download) for the latest application configurations.

### 18.21.1 Fan powered box

FPB051	Fan powered box with series fan on analog output and staged electric reheater on analog output	A6V10662238	<a href="#">en</a> <a href="#">de</a>
--------	--	-------------	---------------------------------------

# 19 Lighting applications

## 19.1 Manual switching or dimmed light

The application controls local switching and dimming of lighting in the room. It is optimized for short response times between pushing the button and the response by the lighting actuator.

The room occupancy has the following commands available to manually operate lighting:

- Switch on
- Switch off
- Dimming up
- Dimming down

### Manual operation overrides automatic

Manual operation by the user can override any existing automation in the room. Any manual operation must be released to return to automatic mode.

DXR2 applications have the following methods to this end:

- A central scheduler program
- Presence detector detecting non-occupancy
- Central commands from the management station
- By manual operation (first-time switch on or appropriately configured button)

Description	Name	Default value
Enable brightness control by switch-on command 0:No 1:Yes	EnBrgtCtlSwiOn	1:Yes

### Burn-in function

Each lighting application function possesses a burn-in function for newly installed fluorescent lights that must be burned in. This ensures that the lights achieve their maximum brightness and life expectancy:

- T5 fluorescent lamps require a burn-in time of 100 hours.
- T8 fluorescent lamps require a burn-in time of 20 hours.

Refer to manufacturer data on fluorescent lights for more detailed information.

You cannot dim fluorescent lights during the burn-in period. You can switch off fluorescent lights during the burn-in period.

The burn-in function ensures that newly installed fluorescent lights are not dimmed during the required burn-in period, either by a control algorithm or manual dimming. The minimum actual value for the lighting output is set to the minimum burn-in value. As a result, the connected lighting can only be switched on or switched on to the minimum burn-in value during the burn-in period.

As soon as the hours of operation counter reaches the required number of hours for burn in, the minimum value of the output lighting (BACnet Property Minimal Actual Value) is set to the value OpMinVal; the maximum value of the output lighting (BACnet Property Maximal Actual Value) is set to the value OpMaxVal.

Description	Name	Default value
Burn-in operating hours	OphBrnin	00:00:00 [hh:mm:ss]
Burn-in minimum value	BrninMinVal	100 [%]
Operating phase minimum value	OpMinVal	0.5 [%]
Operating phase maximum value	OpMaxVal	100 [%]

**Prewarning during switch off**

Each lighting application has a prewarning function. When enabled, the prewarning function does not immediately turn off lighting when the push button is manually pushed. The light blinks in advance for a defined period. The room user can permanently turn on the light again by pressing the button during the prewarning function.

Description	Name	Default value
Prewarning function 0:Disable 1:Enable	PreWarnFnct	0:Disable
Prewarning time	TiPreWarn	60 [s]

**Operating hours counter**

Each lighting application has an operating hours counter. It indicates the time the light was switched on since the last time the counter was reset. Always manually reset the counter if exchanging luminaires. You can reset the counter via central operation or on the DXR2 web server.

Description	Name	Default value
Operating hours	Oph	00:00:00 [hh:mm:ss]

**Control of state LED**

The DXR2 can control KNX PL-Link push buttons or room operator units with integrated LED state displays. The following state displays can be configured:

- **Always off:**  
State LEDs are always switched off on push buttons/room operator unit.
- **Lighting on:**  
The state LEDs for the push buttons (switch off/darker) are switched on if the lights are switched on.
- **Lighting off:**  
The state LEDs for the push buttons (switch on/brighter) are switched on if the lights are switched off.
- **Manual operation lock:**  
All state LEDs are switched on if the push buttons/room operator unit is locked for manual operation.
- **Lighting on, or manual operation lock:**  
The state LEDs of the push buttons (switch off/darker) are switched on if the lights are switched on and all state LEDs are switched on if manual operation is locked.
- **Lighting off, or manual operation lock:**  
The state LEDs of the push buttons (switch on/brighter) are switched on if the lights are switched off and all state LEDs are switched on if manual operation is locked.

Description	Name	Default value
Room operator unit, LED indication	RuLED	Lighting off, or manual operation lock

## 19.2 Stairwell lighting

The application provides scheduled switch off of lighting. Lighting is switched on manually. After the overshoot time, it is automatically switched off. This function is often used in stairwells and hallways. It is optimized for short response times between pushing the button and the response by the lighting actuator.

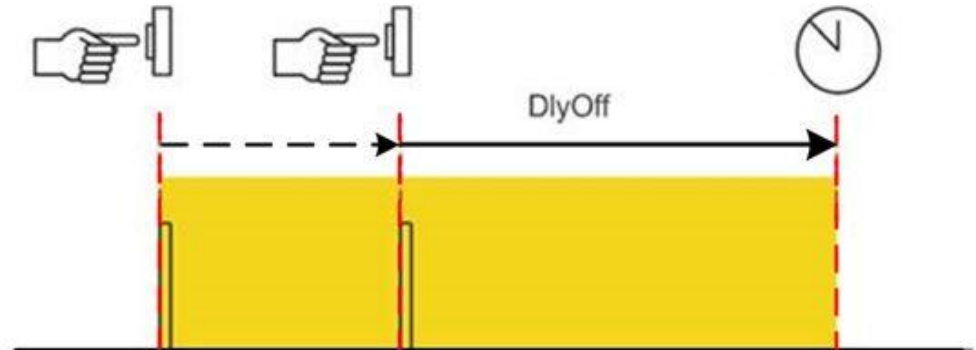

The room occupancy has the following commands available to manually operate lighting:

- Switch on
- Switch off
- Dimming up
- Dimming down

### Automatic switch off

All light applications have an automatic switch-off function. A parameter is used to enable the function. A second parameter determines the switch-off time.

A manually switched light application is configured to create stairwell lighting with the function switched on for automatic switch off.

Description	Name	Default value
Automatic switch-off function 0:Disable 1:Enable	AutoOffFct	0:Disable
Automatic switch-off time	TiAutoOff	60 [s]

**Prewarning during switch off**

Each lighting application has a prewarning function. When enabled, the prewarning function does not immediately turn off lighting when the push button is manually pushed. The light blinks in advance for a defined period. The room user can permanently turn on the light again by pressing the button during the prewarning function.

Description	Name	Default value
Prewarning function 0:Disable 1:Enable	PreWarnFnct	0:Disable
Prewarning time	TiPreWarn	60 [s]

**Manual operation overrides automatic**

Manual operation by the user can override any existing automation in the room. Any manual operation must be released to return to automatic mode.

DXR2 applications have the following methods to this end:

- A central scheduler program
- Presence detector detecting non-occupancy
- Central commands from the management station
- By manual operation (first-time switch on or appropriately configured button)

Description	Name	Default value
Enable brightness control by switch-on command 0:No 1:Yes	EnBrgtCtlSwiOn	1:Yes

**Burn-in function**

Each lighting application function possesses a burn-in function for newly installed fluorescent lights that must be burned in. This ensures that the lights achieve their maximum brightness and life expectancy:

- T5 fluorescent lamps require a burn-in time of 100 hours.
- T8 fluorescent lamps require a burn-in time of 20 hours.

Refer to manufacturer data on fluorescent lights for more detailed information.

You cannot dim fluorescent lights during the burn-in period. You can switch off fluorescent lights during the burn-in period.

The burn-in function ensures that newly installed fluorescent lights are not dimmed during the required burn-in period, either by a control algorithm or manual dimming. The minimum actual value for the lighting output is set to the minimum burn-in value. As a result, the connected lighting can only be switched on or switched on to the minimum burn-in value during the burn-in period.

As soon as the hours of operation counter reaches the required number of hours for burn in, the minimum value of the output lighting (BACnet Property Minimal Actual Value) is set to the value OpMinVal; the maximum value of the output lighting (BACnet Property Maximal Actual Value) is set to the value OpMaxVal.

Description	Name	Default value
Burn-in operating hours	OphBrnin	00:00:00 [hh:mm:ss]
Burn-in minimum value	BrninMinVal	100 [%]
Operating phase minimum value	OpMinVal	0.5 [%]
Operating phase maximum value	OpMaxVal	100 [%]

**Operating hours counter**

Each lighting application has an operating hours counter. It indicates the time the light was switched on since the last time the counter was reset. Always manually reset the counter if exchanging luminaires. You can reset the counter via central operation or on the DXR2 web server.

Description	Name	Default value
Operating hours	Oph	00:00:00 [hh:mm:ss]

### Control of state LED

The DXR2 can control KNX PL-Link push buttons or room operator units with integrated LED state displays. The following state displays can be configured:



- **Always off:**  
State LEDs are always switched off on push buttons/room operator unit.
- **Lighting on:**  
The state LEDs for the push buttons (switch off/darker) are switched on if the lights are switched on.
- **Lighting off:**  
The state LEDs for the push buttons (switch on/brighter) are switched on if the lights are switched off.
- **Manual operation lock:**  
All state LEDs are switched on if the push buttons/room operator unit is locked for manual operation.
- **Lighting on, or manual operation lock:**  
The state LEDs of the push buttons (switch off/darker) are switched on if the lights are switched on and all state LEDs are switched on if manual operation is locked.
- **Lighting off, or manual operation lock:**  
The state LEDs of the push buttons (switch on/brighter) are switched on if the lights are switched off and all state LEDs are switched on if manual operation is locked.

Description	Name	Default value
Room operator unit, LED indication	RuLED	Lighting off, or manual operation lock

## 19.3 Presence-dependent lighting control

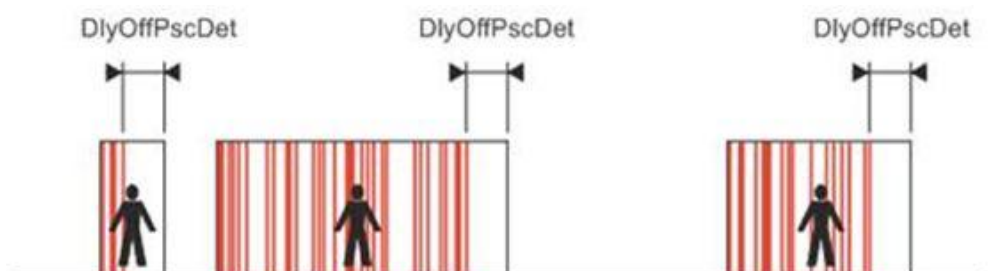
The application switches lighting on and off based on occupancy of people in the room. The presence detector switches to the state occupied when movement is detected. The time between two movements is bridged with a presence detector delay off. Each movement detected by the presence detector restarts the delay off presence detector.



Symbol	Description
	Movement detected by the presence detector. Each movement restarts the delay off presence detector (DlyOffPscDet).
	In use

Description	Name	Default value
Lighting switch-off delay presence detector	LgtDlyOfPscDet	300 [s]

The room occupancy has the following commands available to manually operate lighting:

- Switch on
- Switch off
- Dimming up
- Dimming down

#### Manual operation using the presence button

The presence button is used to establish occupancy in a room. It is used in place of a presence detector. Establishing occupancy with a presence button is not automatic, but rather the result of a user action. When entering the room, the user switches to occupied using a presence button. When exiting the room, the user switches to "absent" using the presence button.

#### Manual operation overrides automatic

Manual operation by the user can override any existing automation in the room. Any manual operation must be released to return to automatic mode.

DXR2 applications have the following methods to this end:

- A central scheduler program
- Presence detector detecting non-occupancy
- Central commands from the management station
- By manual operation (first-time switch on or appropriately configured button)

Description	Name	Default value
Enable brightness control by switch-on command 0:No 1:Yes	EnBrgtCtlSwiOn	1:Yes



**Burn-in function**

Each lighting application function possesses a burn-in function for newly installed fluorescent lights that must be burned in. This ensures that the lights achieve their maximum brightness and life expectancy:

- T5 fluorescent lamps require a burn-in time of 100 hours.
- T8 fluorescent lamps require a burn-in time of 20 hours.

Refer to manufacturer data on fluorescent lights for more detailed information.

You cannot dim fluorescent lights during the burn-in period. You can switch off fluorescent lights during the burn-in period.

The burn-in function ensures that newly installed fluorescent lights are not dimmed during the required burn-in period, either by a control algorithm or manual dimming. The minimum actual value for the lighting output is set to the minimum burn-in value. As a result, the connected lighting can only be switched on or switched on to the minimum burn-in value during the burn-in period.

As soon as the hours of operation counter reaches the required number of hours for burn in, the minimum value of the output lighting (BACnet Property Minimal Actual Value) is set to the value OpMinVal; the maximum value of the output lighting (BACnet Property Maximal Actual Value) is set to the value OpMaxVal.

Description	Name	Default value
Burn-in operating hours	OphBrnin	00:00:00 [hh:mm:ss]
Burn-in minimum value	BrninMinVal	100 [%]
Operating phase minimum value	OpMinVal	0.5 [%]
Operating phase maximum value	OpMaxVal	100 [%]

**Prewarning during switch off**

Each lighting application has a prewarning function. When enabled, the prewarning function does not immediately turn off lighting when the push button is manually pushed. The light blinks in advance for a defined period. The room user can permanently turn on the light again by pressing the button during the prewarning function.

Description	Name	Default value
Prewarning function 0:Disable 1:Enable	PreWarnFnct	0:Disable
Prewarning time	TiPreWarn	60 [s]

**Operating hours counter**

Each lighting application has an operating hours counter. It indicates the time the light was switched on since the last time the counter was reset. Always manually reset the counter if exchanging luminaires. You can reset the counter via central operation or on the DXR2 web server.

Description	Name	Default value
Operating hours	Oph	00:00:00 [hh:mm:ss]

**Control of state LED**

The DXR2 can control KNX PL-Link push buttons or room operator units with integrated LED state displays. The following state displays can be configured:

- **Always off:**  
State LEDs are always switched off on push buttons/room operator unit.
- **Lighting on:**  
The state LEDs for the push buttons (switch off/darker) are switched on if the lights are switched on.
- **Lighting off:**  
The state LEDs for the push buttons (switch on/brighter) are switched on if the lights are switched off.
- **Manual operation lock:**  
All state LEDs are switched on if the push buttons/room operator unit is locked for manual operation.
- **Lighting on, or manual operation lock:**  
The state LEDs of the push buttons (switch off/darker) are switched on if the lights are switched on and all state LEDs are switched on if manual operation is locked.
- **Lighting off, or manual operation lock:**  
The state LEDs of the push buttons (switch on/brighter) are switched on if the lights are switched off and all state LEDs are switched on if manual operation is locked.

Description	Name	Default value
Room operator unit, LED indication	RuLED	Lighting off, or manual operation lock

## 19.4 Control for daylight based lighting and dusk/dawn switching

The application automatically turns off lighting if sufficient daylight is measured in the room and turns it back on for too little daylight. It requires a brightness sensor in the room. The automatic function for turning off the lights can also be locked or enabled.

The application can also be used to implement dawn/dusk switching. The application turns on lighting in the room at dawn/dusk. An outdoor brightness sensor can be used instead of placing a brightness sensor in the room.

Description	Name	Default value
Enable daylight measurement 0:No 1:Yes	EnDlgtMsm	0:Yes

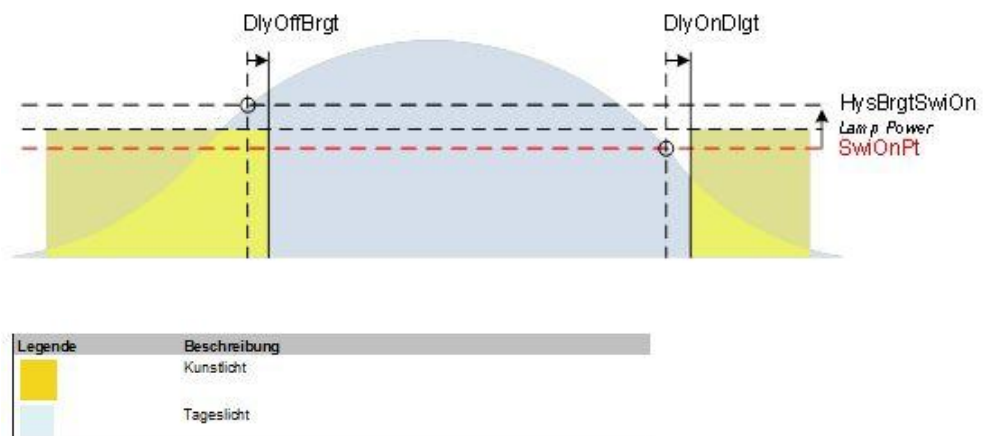

### Influence of daylight and artificial light

The parameters luminance, correction factor daylight, and correction factor artificial light must be determined by the corresponding brightness measurement in the room and saved to the automation station to ensure daylight-dependent lighting in the room is operating properly.

The room occupancy has the following commands available to manually operate lighting:

- Switch on
- Switch off
- Dimming up
- Dimming down

### Manual operation overrides automatic

Manual operation by the user can override any existing automation in the room. Any manual operation must be released to return to automatic mode.

DXR2 applications have the following methods to this end:

- A central scheduler program
- Presence detector detecting non-occupancy
- Central commands from the management station
- By manual operation (first-time switch on or appropriately configured button)

Description	Name	Default value
Enable brightness control by switch-on command 0:No 1:Yes	EnBrgtCtlSwiOn	1:Yes

### Burn-in function

Each lighting application function possesses a burn-in function for newly installed fluorescent lights that must be burned in. This ensures that the lights achieve their maximum brightness and life expectancy:

- T5 fluorescent lamps require a burn-in time of 100 hours.
- T8 fluorescent lamps require a burn-in time of 20 hours.

Refer to manufacturer data on fluorescent lights for more detailed information.

You cannot dim fluorescent lights during the burn-in period. You can switch off fluorescent lights during the burn-in period.

The burn-in function ensures that newly installed fluorescent lights are not dimmed during the required burn-in period, either by a control algorithm or manual dimming. The minimum actual value for the lighting output is set to the minimum burn-in value. As a result, the connected lighting can only be switched on or switched on to the minimum burn-in value during the burn-in period.

As soon as the hours of operation counter reaches the required number of hours for burn in, the minimum value of the output lighting (BACnet Property Minimal Actual Value) is set to the value OpMinVal; the maximum value of the output lighting (BACnet Property Maximal Actual Value) is set to the value OpMaxVal.

Description	Name	Default value
Burn-in operating hours	OphBrnin	00:00:00 [hh:mm:ss]
Burn-in minimum value	BrninMinVal	100 [%]
Operating phase minimum value	OpMinVal	0.5 [%]
Operating phase maximum value	OpMaxVal	100 [%]

### Prewarning during switch off

Each lighting application has a prewarning function. When enabled, the prewarning function does not immediately turn off lighting when the push button is manually pushed. The light blinks in advance for a defined period. The room user can permanently turn on the light again by pressing the button during the prewarning function.

Description	Name	Default value
Prewarning function 0:Disable 1:Enable	PreWarnFnct	0:Disable
Prewarning time	TiPreWarn	60 [s]

### Operating hours counter

Each lighting application has an operating hours counter. It indicates the time the light was switched on since the last time the counter was reset. Always manually reset the counter if exchanging luminaires. You can reset the counter via central operation or on the DXR2 web server.

Description	Name	Default value
Operating hours	Oph	00:00:00 [hh:mm:ss]

**Control of state LED**

The DXR2 can control KNX PL-Link push buttons or room operator units with integrated LED state displays. The following state displays can be configured:

- **Always off:**  
State LEDs are always switched off on push buttons/room operator unit.
- **Lighting on:**  
The state LEDs for the push buttons (switch off/darker) are switched on if the lights are switched on.
- **Lighting off:**  
The state LEDs for the push buttons (switch on/brighter) are switched on if the lights are switched off.
- **Manual operation lock:**  
All state LEDs are switched on if the push buttons/room operator unit is locked for manual operation.
- **Lighting on, or manual operation lock:**  
The state LEDs of the push buttons (switch off/darker) are switched on if the lights are switched on and all state LEDs are switched on if manual operation is locked.
- **Lighting off, or manual operation lock:**  
The state LEDs of the push buttons (switch on/brighter) are switched on if the lights are switched off and all state LEDs are switched on if manual operation is locked.

Description	Name	Default value
Room operator unit, LED indication	RuLED	Lighting off, or manual operation lock

## 19.5 Constant lighting control with one light group in the room

The constant lighting control application ensures seamless control of artificial light based on room brightness. A brightness sensor mounted on the ceiling in a room acquires the brightness in the room as a sum total of artificial light and daylight. The previously defined brightness value in the room is maintained at a constant level. Artificial light is switched off if not needed.

When adding presence detectors, lighting is controlled based on daylight and occupancy.

A lighting group controls in the room:

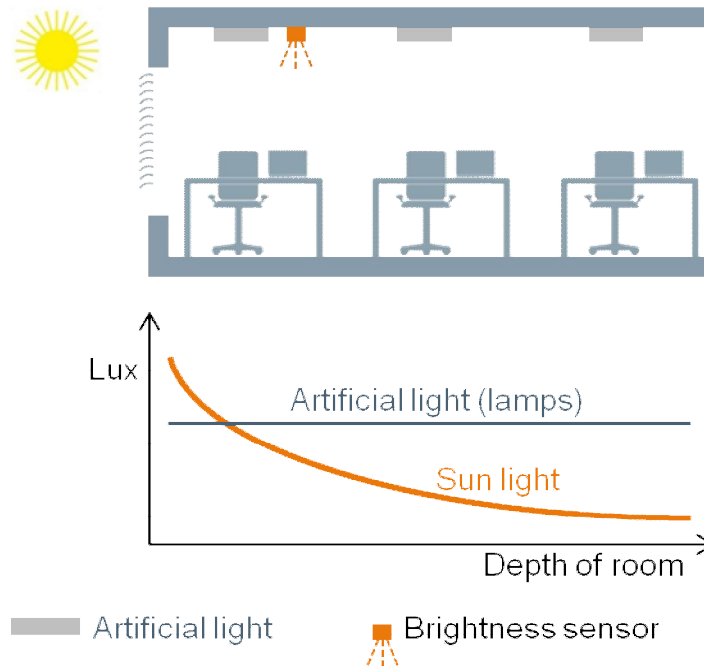

#### Influence of daylight and artificial light

The parameters luminance, correction factor daylight, and correction factor artificial light must be determined by the corresponding brightness measurement in the room and saved to the automation station to ensure daylight-dependent lighting in the room is operating properly.

The room occupancy has the following commands available to manually operate lighting:

- Switch on
- Switch off
- Dimming up
- Dimming down

#### Manual operation using the presence button

The presence button is used to establish occupancy in a room. It is used in place of a presence detector. Establishing occupancy with a presence button is not automatic, but rather the result of a user action. When entering the room, the user switches to occupied using a presence button. When exiting the room, the user switches to "absent" using the presence button.

#### Manual operation overrides automatic

Manual operation by the user can override any existing automation in the room. Any manual operation must be released to return to automatic mode.

DXR2 applications have the following methods to this end:

- A central scheduler program
- Presence detector detecting non-occupancy
- Central commands from the management station
- By manual operation (first-time switch on or appropriately configured button)

Description	Name	Default value
Enable brightness control by switch-on command 0:No 1:Yes	EnBrgtCtlSwiOn	1:Yes

**Burn-in function**

Each lighting application function possesses a burn-in function for newly installed fluorescent lights that must be burned in. This ensures that the lights achieve their maximum brightness and life expectancy:

- T5 fluorescent lamps require a burn-in time of 100 hours.
- T8 fluorescent lamps require a burn-in time of 20 hours.

Refer to manufacturer data on fluorescent lights for more detailed information.

You cannot dim fluorescent lights during the burn-in period. You can switch off fluorescent lights during the burn-in period.

The burn-in function ensures that newly installed fluorescent lights are not dimmed during the required burn-in period, either by a control algorithm or manual dimming. The minimum actual value for the lighting output is set to the minimum burn-in value. As a result, the connected lighting can only be switched on or switched on to the minimum burn-in value during the burn-in period.

As soon as the hours of operation counter reaches the required number of hours for burn in, the minimum value of the output lighting (BACnet Property Minimal Actual Value) is set to the value OpMinVal; the maximum value of the output lighting (BACnet Property Maximal Actual Value) is set to the value OpMaxVal.

Description	Name	Default value
Burn-in operating hours	OphBrnin	00:00:00 [hh:mm:ss]
Burn-in minimum value	BrninMinVal	100 [%]
Operating phase minimum value	OpMinVal	0.5 [%]
Operating phase maximum value	OpMaxVal	100 [%]

**Prewarning during switch off**

Each lighting application has a prewarning function. When enabled, the prewarning function does not immediately turn off lighting when the push button is manually pushed. The light blinks in advance for a defined period. The room user can permanently turn on the light again by pressing the button during the prewarning function.

Description	Name	Default value
Prewarning function 0:Disable 1:Enable	PreWarnFnct	0:Disable
Prewarning time	TiPreWarn	60 [s]

**Operating hours counter**

Each lighting application has an operating hours counter. It indicates the time the light was switched on since the last time the counter was reset. Always manually reset the counter if exchanging luminaires. You can reset the counter via central operation or on the DXR2 web server.

Description	Name	Default value
Operating hours	Oph	00:00:00 [hh:mm:ss]

**Control of state LED**

The DXR2 can control KNX PL-Link push buttons or room operator units with integrated LED state displays. The following state displays can be configured:

- **Always off:**  
State LEDs are always switched off on push buttons/room operator unit.
- **Lighting on:**  
The state LEDs for the push buttons (switch off/darker) are switched on if the lights are switched on.
- **Lighting off:**  
The state LEDs for the push buttons (switch on/brighter) are switched on if the lights are switched off.
- **Manual operation lock:**  
All state LEDs are switched on if the push buttons/room operator unit is locked for manual operation.
- **Lighting on, or manual operation lock:**  
The state LEDs of the push buttons (switch off/darker) are switched on if the lights are switched on and all state LEDs are switched on if manual operation is locked.
- **Lighting off, or manual operation lock:**  
The state LEDs of the push buttons (switch on/brighter) are switched on if the lights are switched off and all state LEDs are switched on if manual operation is locked.

Description	Name	Default value
Room operator unit, LED indication	RuLED	Lighting off, or manual operation lock

## 19.6 Constant lighting control with multiple lighting groups in the room

The constant lighting control application ensures seamless control of artificial light based on room brightness. Brightness of additional lighting groups is individually calculated using the calculated brightness of the controlled main lighting group and illumination fall-up characteristics, considered from the window to inside the room. Each lighting group is individually controlled in the room which additionally lowers energy demand for lighting.

A brightness sensor mounted on the ceiling in a room acquires the brightness in the room as a sum total of artificial light and daylight. The previously defined brightness value of the lighting group is maintained at a constant level. Artificial light is switched off if not needed.



When adding presence detectors, lighting is controlled based on daylight and occupancy.

Multiple lighting groups control in the room:

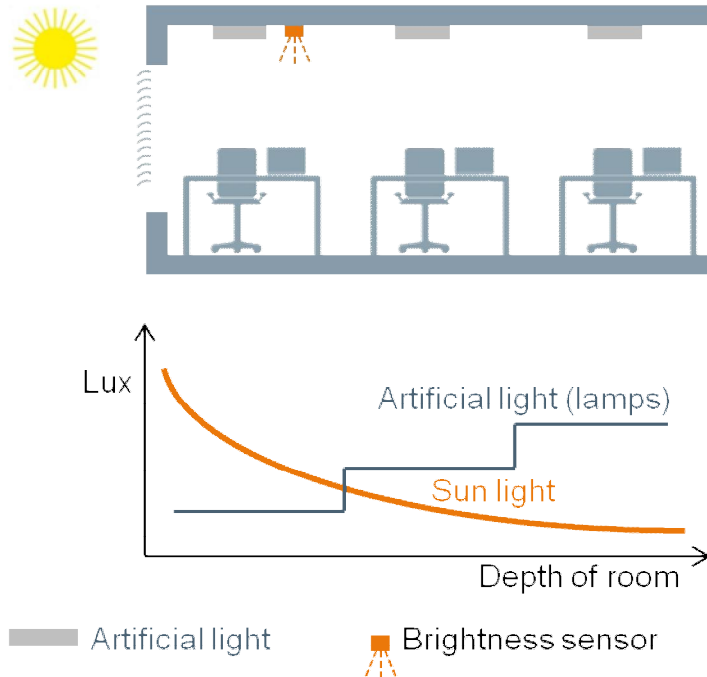

### Influence of daylight and artificial light

The parameters luminance, correction factor daylight, and correction factor artificial light must be determined by the corresponding brightness measurement in the room and saved to the automation station to ensure daylight-dependent lighting in the room is operating properly.

The room occupancy has the following commands available to manually operate lighting:

- Switch on
- Switch off
- Dimming up
- Dimming down

### Manual operation using the presence button

The presence button is used to establish occupancy in a room. It is used in place of a presence detector. Establishing occupancy with a presence button is not automatic, but rather the result of a user action. When entering the room, the user switches to occupied using a presence button. When exiting the room, the user switches to "absent" using the presence button.

### Manual operation overrides automatic

Manual operation by the user can override any existing automation in the room. Any manual operation must be released to return to automatic mode.

DXR2 applications have the following methods to this end:

- A central scheduler program
- Presence detector detecting non-occupancy
- Central commands from the management station
- By manual operation (first-time switch on or appropriately configured button)

Description	Name	Default value
Enable brightness control by switch-on command 0:No 1:Yes	EnBrgtCtlSwiOn	1:Yes

**Burn-in function**

Each lighting application function possesses a burn-in function for newly installed fluorescent lights that must be burned in. This ensures that the lights achieve their maximum brightness and life expectancy:

- T5 fluorescent lamps require a burn-in time of 100 hours.
- T8 fluorescent lamps require a burn-in time of 20 hours.

Refer to manufacturer data on fluorescent lights for more detailed information.

You cannot dim fluorescent lights during the burn-in period. You can switch off fluorescent lights during the burn-in period.

The burn-in function ensures that newly installed fluorescent lights are not dimmed during the required burn-in period, either by a control algorithm or manual dimming. The minimum actual value for the lighting output is set to the minimum burn-in value. As a result, the connected lighting can only be switched on or switched on to the minimum burn-in value during the burn-in period.

As soon as the hours of operation counter reaches the required number of hours for burn in, the minimum value of the output lighting (BACnet Property Minimal Actual Value) is set to the value OpMinVal; the maximum value of the output lighting (BACnet Property Maximal Actual Value) is set to the value OpMaxVal.

Description	Name	Default value
Burn-in operating hours	OphBrnin	00:00:00 [hh:mm:ss]
Burn-in minimum value	BrninMinVal	100 [%]
Operating phase minimum value	OpMinVal	0.5 [%]
Operating phase maximum value	OpMaxVal	100 [%]

**Prewarning during switch off**

Each lighting application has a prewarning function. When enabled, the prewarning function does not immediately turn off lighting when the push button is manually pushed. The light blinks in advance for a defined period. The room user can permanently turn on the light again by pressing the button during the prewarning function.

Description	Name	Default value
Prewarning function 0:Disable 1:Enable	PreWarnFnct	0:Disable
Prewarning time	TiPreWarn	60 [s]

**Operating hours counter**

Each lighting application has an operating hours counter. It indicates the time the light was switched on since the last time the counter was reset. Always manually reset the counter if exchanging luminaires. You can reset the counter via central operation or on the DXR2 web server.

Description	Name	Default value
Operating hours	Oph	00:00:00 [hh:mm:ss]

## Control of state LED

The DXR2 can control KNX PL-Link push buttons or room operator units with integrated LED state displays. The following state displays can be configured:

- **Always off:**  
State LEDs are always switched off on push buttons/room operator unit.
- **Lighting on:**  
The state LEDs for the push buttons (switch off/darker) are switched on if the lights are switched on.
- **Lighting off:**  
The state LEDs for the push buttons (switch on/brighter) are switched on if the lights are switched off.
- **Manual operation lock:**  
All state LEDs are switched on if the push buttons/room operator unit is locked for manual operation.
- **Lighting on, or manual operation lock:**  
The state LEDs of the push buttons (switch off/darker) are switched on if the lights are switched on and all state LEDs are switched on if manual operation is locked.
- **Lighting off, or manual operation lock:**  
The state LEDs of the push buttons (switch on/brighter) are switched on if the lights are switched off and all state LEDs are switched on if manual operation is locked.

Description	Name	Default value
Room operator unit, LED indication	RuLED	Lighting off, or manual operation lock

## 19.7 Operating strategy for light

Desigo room automation has various room operating modes available to efficiently control lighting. The system can, depending on the selected room operating mode, reduce light output in the rooms through the use of automatic light functions. This generally occurs during periods of absence, at night, during holidays, when spaces are not occupied.

Four different room operating modes are available that can execute control, via central functions, management stations, schedulers, presence buttons in the room or other BACnet participants in the system.

With Desigo room automation, the operating modes "Economy" and "Protection" can determine how much light output is automatically reduced. In operating modes, "Comfort" and "Pre-Comfort", lighting control is conversely not reduced using automatic light functions, so that lighting can be controlled to the maximum.

The reduced control for the corresponding operating mode refers to dimmable lighting in the room. Moreover, the reduction to light output does not include manual control of lighting using operator buttons in the room. A room occupant is always able to control the full illuminance.

Comfort = max. 100% lighting

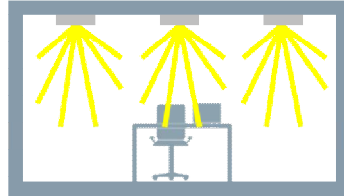

Economy = max. 50% lighting

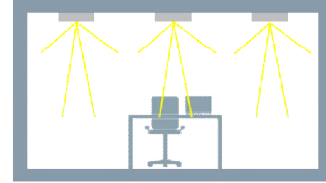

### Room operating modes

Four different room operating modes are available that can execute control, via central functions, management stations, schedulers, presence buttons in the room or other BACnet participants in the system.

**Comfort:** The operating mode Comfort refers to a room currently in use (occupied).

**Pre-Comfort:** The Pre-Comfort operating mode places control for an unoccupied room in a state that can be quickly reset to the desired setpoints for an occupied room.

**Economy:** The Economy operating mode controls rooms that remain unoccupied for an extended period, for example, at night or over the weekend.

**Protection:** The building is unoccupied over longer periods in this operating mode (e.g. no renters, factory holidays).

The room occupancy has the following commands available to manually operate lighting:

- Switch on
- Switch off
- Dimming up
- Dimming down

### Manual operation using the presence button

The presence button is used to establish occupancy in a room. It is used in place of a presence detector. Establishing occupancy with a presence button is not automatic, but rather the result of a user action. When entering the room, the user switches to occupied using a presence button. When exiting the room, the user switches to "absent" using the presence button.

### Manual operation overrides automatic

Manual operation by the user can override any existing automation in the room. Any manual operation must be released to return to automatic mode.

DXR2 applications have the following methods to this end:

- A central scheduler program
- Presence detector detecting non-occupancy
- Central commands from the management station
- By manual operation (first-time switch on or appropriately configured button)

Description	Name	Default value
Enable brightness control by switch-on command 0:No 1:Yes	EnBrgtCtlSwiOn	1:Yes

### Burn-in function

Each lighting application function possesses a burn-in function for newly installed fluorescent lights that must be burned in. This ensures that the lights achieve their maximum brightness and life expectancy:

- T5 fluorescent lamps require a burn-in time of 100 hours.
- T8 fluorescent lamps require a burn-in time of 20 hours.

Refer to manufacturer data on fluorescent lights for more detailed information.

You cannot dim fluorescent lights during the burn-in period. You can switch off fluorescent lights during the burn-in period.

The burn-in function ensures that newly installed fluorescent lights are not dimmed during the required burn-in period, either by a control algorithm or manual dimming. The minimum actual value for the lighting output is set to the minimum burn-in value. As a result, the connected lighting can only be switched on or switched on to the minimum burn-in value during the burn-in period.

As soon as the hours of operation counter reaches the required number of hours for burn in, the minimum value of the output lighting (BACnet Property Minimal Actual Value) is set to the value OpMinVal; the maximum value of the output lighting (BACnet Property Maximal Actual Value) is set to the value OpMaxVal.

Description	Name	Default value
Burn-in operating hours	OphBrnin	00:00:00 [hh:mm:ss]
Burn-in minimum value	BrninMinVal	100 [%]
Operating phase minimum value	OpMinVal	0.5 [%]
Operating phase maximum value	OpMaxVal	100 [%]

### Prewarning during switch off

Each lighting application has a prewarning function. When enabled, the prewarning function does not immediately turn off lighting when the push button is manually pushed. The light blinks in advance for a defined period. The room user can permanently turn on the light again by pressing the button during the prewarning function.

Description	Name	Default value
Prewarning function 0:Disable 1:Enable	PreWarnFnct	0:Disable
Prewarning time	TiPreWarn	60 [s]

### Operating hours counter

Each lighting application has an operating hours counter. It indicates the time the light was switched on since the last time the counter was reset. Always manually reset the counter if exchanging luminaires. You can reset the counter via central operation or on the DXR2 web server.

Description	Name	Default value
Operating hours	Oph	00:00:00 [hh:mm:ss]

**Control of state LED**

The DXR2 can control KNX PL-Link push buttons or room operator units with integrated LED state displays. The following state displays can be configured:

- **Always off:**  
State LEDs are always switched off on push buttons/room operator unit.
- **Lighting on:**  
The state LEDs for the push buttons (switch off/darker) are switched on if the lights are switched on.
- **Lighting off:**  
The state LEDs for the push buttons (switch on/brighter) are switched on if the lights are switched off.
- **Manual operation lock:**  
All state LEDs are switched on if the push buttons/room operator unit is locked for manual operation.
- **Lighting on, or manual operation lock:**  
The state LEDs of the push buttons (switch off/darker) are switched on if the lights are switched on and all state LEDs are switched on if manual operation is locked.
- **Lighting off, or manual operation lock:**  
The state LEDs of the push buttons (switch on/brighter) are switched on if the lights are switched off and all state LEDs are switched on if manual operation is locked.

Description	Name	Default value
Room operator unit, LED indication	RuLED	Lighting off, or manual operation lock

## 20 Blinds applications

### 20.1 Local blinds operations

This application control local operation of shading in the room. It is optimized for short response times between pushing the button and the response by the lighting actuator.

The room occupancy has the following commands are available to manually operate shading:

- Up
- Down
- Stop and step up
- Stop and step down

#### Manual operation overrides automatic

Manual operation by the user can override any existing automation in the room. Any manual operation must be released to return to automatic mode.

DXR2 applications have the following methods to this end:

- A central scheduler program
- Presence detector detecting non-occupancy
- Central commands from the management station
- By manual operation (first-time switch on or appropriately configured button)

#### LED indication on buttons

The LED feedback to the KNX PL-Link pushbutton pairs can be used to provide the room user with feedback as to whether manual operation for shading is enabled or locked. The LED feedback can also be disabled in another operating mode. LED feedback is then switched off.

Description	Name	Default value
0:Always off 1:Manual operation locked	LED indication	0: LEDs switched off 1:0=Man. operation enabled, 1=Man. operation locked

#### Group operation

Multiple blinds can be manually raised and lowered with a pushbutton pair in the room. The corresponding blinds can be assigned to the push button pair.

## Protection functions

<b>Safety of persons</b>	Blinds are opened during a fire to allow people to exit through a window or help emergency responders access the facility.
<b>Collision protection</b>	Collision protection prevents blinds from closing if a window or door is opened to the outside.
<b>Wind protection</b>	The protection function ensures that all blinds are commanded to a safe position during strong winds.
<b>Maintenance work</b>	The blinds are commanded to a defined position and blocked so that no person is endangered.
<b>Delays central commands</b>	Delays to blinds start up are automatically considered when commanding all blinds on a facade by a central function to prevent the start-up current for blinds motors from negatively impacting or even overloading the building.
<b>Monitoring blinds actuators for faults</b>	<p>The function monitors communications with the blinds actuators of the Desigo room automation. The management station sends a fault message if communication fails between the Desigo room automation station and blinds actuators. So that appropriate measures can be taken.</p> <p>See central functions for additional information on protection functions.</p>
<b>Central functions</b>	<p>Central functions for anti-glare protection, solar position tracking of slats, annual shading and energy efficiency functions for blinds are included in the automatic functions.</p> <p>See description of central functions for additional information on automatic functions.</p>



## 20.2 Operating strategy for blinds

Desigo room automation has various room operating modes available to efficiently control shading. The system can efficiently control the room depending on the selected room operating mode. This generally occurs during periods of absence, at night, during holidays, when spaces are not occupied.

Optimum room shading must satisfy both energy and comfort-related demands. The following factors are considered:

- Presence in the room
- Brightness value (glare, use of daylight).
- Global radiation (energy entry in room).
- Solar radiation angle on facade (basis for optimum slat angle and/or blind height).
- Heating and cooling demand of room.

See description Central Functions.

### Room operating modes

Four different room operating modes are available that can execute control, via central functions, management stations, schedulers, presence buttons in the room or other BACnet participants in the system.

**Comfort:** The operating mode Comfort refers to a room currently in use (occupied).

**Pre-Comfort:** The Pre-Comfort operating mode places control for an unoccupied room in a state that can be quickly reset to the desired setpoints for an occupied room.

**Economy:** The Economy operating mode controls rooms that remain unoccupied for an extended period, for example, at night or over the weekend.

**Protection:** The building is unoccupied over longer periods in this operating mode (e.g. no renters, factory holidays).

Description	Name	Default value
Operating strategy for <b>Comfort</b> 1:Energy efficiency 2:Anti-glare protection 3:Up 4:Down 5:Presence-dependent	OpStrgyCmf	2:Anti-glare protection
Operating strategy for <b>Pre-Comfort</b>	OpStrgyPcf	2:Anti-glare protection
Operating strategy for <b>Economy</b>	OpStrgyEco	1:Energy efficiency
Operating strategy for <b>Protection</b>	OpStrgyPrt	4:Down

### Shading automation

Shading automation includes the functions anti-glare protection, solar position tracking of slats, annual shading, and energy efficiency functions. Curtains are commanded to height and angle via shading automatic functions. All automatic functions are controlled with Desigo room automation by central functions.

See description Central Functions.

Manual, local operation always overrides automatic. The local, manual commands can also be reset, and automatic functions reactivated. It can occur using a time-controlled reset command from the central functions. A presence detector can also reset blinds to automatic after exiting the room.

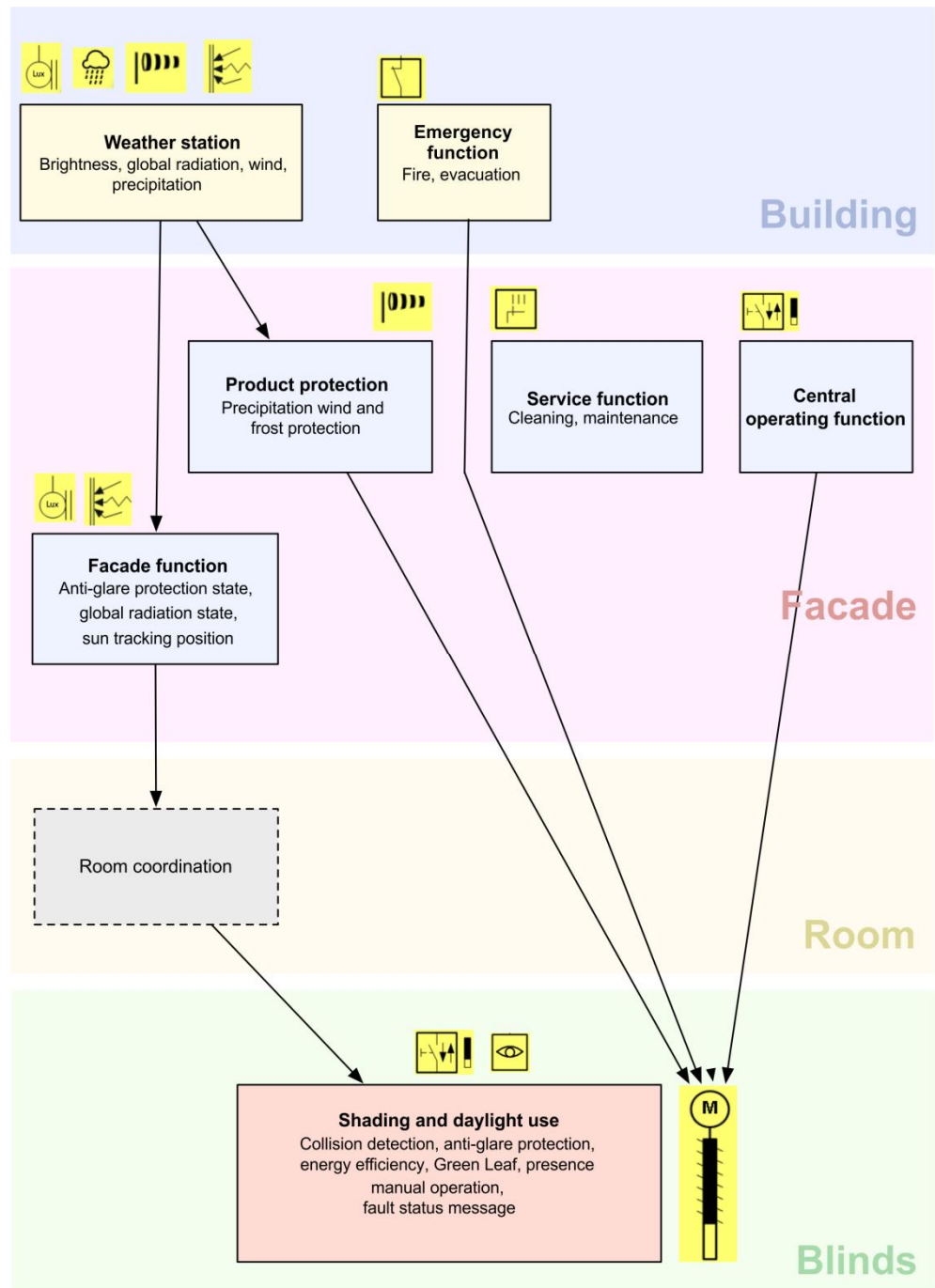

Figure: Overview of shading functions

## 21 Central applications

### Central functions

The configurable DXR2 room automation provides the following central functions. The functions are used to coordinate supply and demand signals for the entire building or large sections thereof between the rooms and generation plants.

- Central operating groups including room operating mode, setpoints, and seasonal compensation, lighting, shading, and emergency commands
- Demand-dependent hot water supply system with temperature setpoint
- Demand-dependent cooling water supply system with temperature setpoint, adjustment to prevent condensation, and calculating free cooling
- Demand-dependent 2-pipe supply system for heating/cooling water including temperature setpoint, changeover, and calculation of free cooling
- Demand-dependent air handling unit (supply and extract air) including temperature setpoint, maximum humidity setpoint, pressure setpoint, maintaining a minimum central air flow, calculating air flow deviation, and cumulative air flow setpoints
- VAV emergency group including shutdown, fume hood, pressure development, or purge
- Information of central weather station includes outside air temperature, outside brightness, solar radiation, wind speed, and precipitation
- Central facade functions for shading, including brightness calculation, central operating group for facade, or anti-glare protection calculation
- Central shading protection group for wind, precipitation, and frost protection, staged distribution of blinds commands in large buildings

### Load central functions on a DXR2.E/M18

The central functions are available to the DXR2.E/M18. This application type is not preloaded at the factors, but rather must be downloaded for a specific project to one or more DXR2.E/M18s.

As a rule, all central functions can be configured on a DXR2. All central functions can be selected and configured on the application type for central functions. Various aspects on a project define how many DXR2 are used with central functions:

### Required I/Os

The planned use of onboard inputs for the applicable central functions (e.g. outside temperature sensor for HVAC supply function, wind sensor for facade protection function, etc.) determines possible distribution of central functions to multiple automation stations.

### Required supply groups

One DXR2 with central functions can control the following number of supply groups:

- 4 x controls for a facade with 4 facade segments each (3 of which can be delayed)
- 4 x groups for distributing room operating mode to rooms
- 2 x Hot water supply groups
- 2 x Chilled water supply groups
- 1 x Air supply group (based on demand)
- 2 x HVAC emergency controls (off, positive pressure, negative pressure, or purge)
- 2 x groups for central control of light and all facades with 4 facade segments each (3 of which can be delayed)
- 1 x group for emergency control of facades with 4 facade segments each (3 of which can be delayed)

- 1 x group for protection function of facades with 4 facade segments each (3 of which can be delayed)
- 1 x group for service function of facades with 4 facade segments each (3 of which can be delayed)
- 1 x group for emergency control of all luminaires

**Sensor placement**

Connect all sensors directly to the DXR2 for central functions via analog or digital I/Os. A DXR2 for central functions may be required at multiple locations in the building depending on the position of the sensors (e.g. wind sensors). The functions belonging to the sensors must be configured on each DXR2 to which the corresponding sensor is connected.

**Recommendation**

4 different configurations for central functions are recommended to simplify configuration. The 4 configurations are described in the following sections. Each of the configurations can be used and installed multiple times on a project (e.g. if more HVAC hot water supply groups are required).

## 21.1 Automation station for HVAC supply and demand signals and manual control for lighting and blinds

**Room operating mode**

The DXR2 receives commands to change room operating mode via digital inputs and takes over control of the electrical and mechanical installations light, facade, and HVAC in the room.

The command to changeover room operating modes can be created using a BACnet reference.

**Central manual operation of lighting and blinds**

Each central automation station can manually operate 2 central groups for lighting and 2 central groups for blinds via the KNX PL-Link switch.

**HVAC supply and demand signals**

The HVAC supply and demand signals are available in the DXR2 system as BACnet data points can be read and written by each BACnet primary plant. HVAC supply and demand signals cannot be created via analog and digital inputs.

One DXR2 with central functions, can control a maximum of:

- 4 x groups for distributing room operating mode to rooms
- 2 x Hot water supply groups
- 2 x Chilled water supply groups
- 1 x Air supply group (based on demand)

If more supply groups are required, additional DXR2 automation stations can be installed and operated for HVAC supply and demand signals.

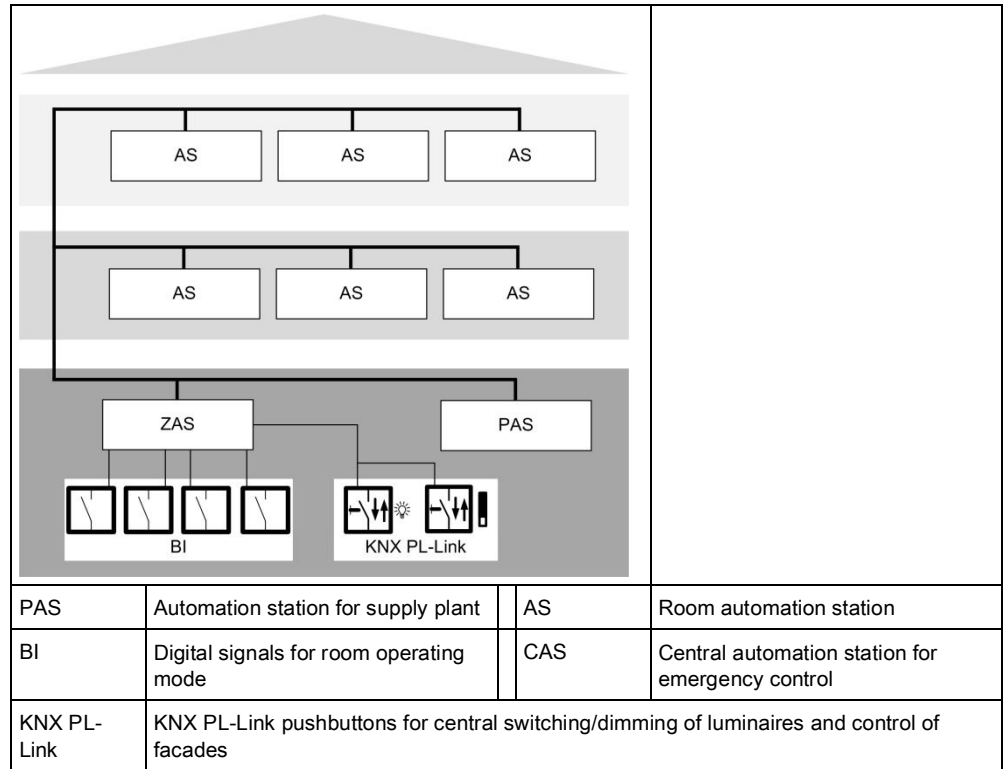

Figure: Plant diagram for HVAC supply/demand signal automation station

### 21.1.1 Control room operating mode via onboard I/Os

The following input signals can be read on DXR2 for central control of room operating mode:

Command	Inputs	Information is used for
Room operating mode switch 1	Digital (No contact)	Application: Central operating mode determination
Room operating mode switch 2	Digital (No contact)	Application: Central operating mode determination
Room operating mode switch 3	Digital (No contact)	Application: Central operating mode determination
Room operating mode 4	Digital (No contact)	Application: Central operating mode determination

Digital commands can be used to change between 2 configured room operating modes per group.

### Delay function on large facades

Each of the central commands for the room operating mode can be delayed in the building using three additional groups. It is used primarily in buildings with larger facades if control influences act on facades for a change to the room operating mode. The delay can be configured.

Description	Name	Default value
Central operating mode delay 1 0...7200 [s]	CenOpModDly1	10 [s]
Central operating mode delay 2 0...7200 [s]	CenOpModDly2	20 [s]
Central operating mode delay 3 0...7200 [s]	CenOpModDly3	30 [s]

## 21.1.2 Manual control of lighting & blinds via KNX PL-Link

The following input signals can be read to DXR2 for the central, manual control for lighting and blinds:

Command	Inputs	Information is used for
Manual operation lighting 1	KNX PL-Link	Application: Central manual operation lighting
Manual operation lighting 2	KNX PL-Link	Application: Central manual operation lighting
Manual operation shading products 1	KNX PL-Link	Application: Central operation of shading products
Manual operation shading products 2	KNX PL-Link	Application: Central operation of shading products

### 21.1.3 HVAC supply chain chilled water over BACnet

The following list includes all data points that can be read and written from a BACnet primary plant. The items ensure coordination between primary plant and the room. In addition, appropriate Desigo primary application for the given room function is mentioned.

Data point name	Description	Desigo primary application
CReq	The central function prepares one chilled water demand acquisition and evaluation to the connected rooms for the primary plant. The enumerate result can include: 1:Off 2:Cooling demand 3:Free cooling 4:Cooling demand & free cooling Values 3 and 4 set refrigeration generation to free cooling on primary chilled water generation.	PXC {CGrp65}
SpCReq	Setpoint for cooling request	PXC {CGrp65}
FreeCAvl	Free cooling available 0:No 1:Yes	PXC {CGen10}
FreeCTChw	Free cooling temperature chilled water	PXC {CGen10}
ChwTOa	BACnet reference for primary plant: Outside temperature of the chilled water supply chain	Data point outside temperature of chilled water supply chain

#### Setpoint for cooling request

Setpoint for cooling request influenced by:

- Base setpoint for cooling
- Valve position(s) of cooling valve in the group
- Number of active condensation monitor in the group
- Dew points

The cooling request setpoint is influenced by the evaluation of valve positions.

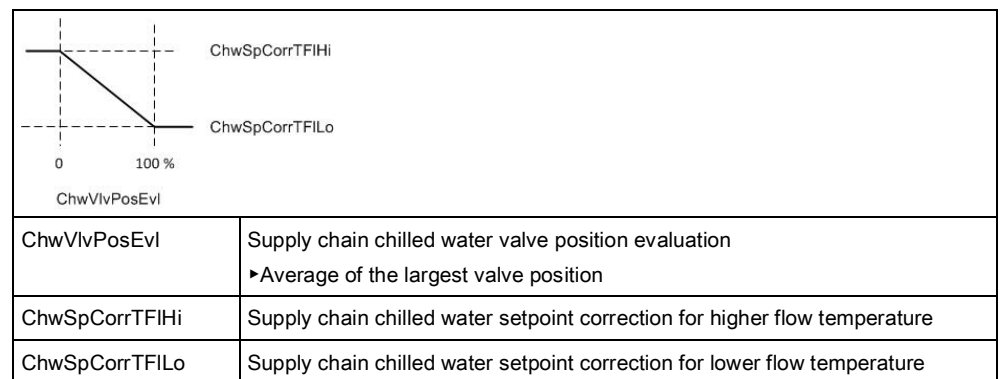

Figure: Setpoint cooling request

**Free cooling**

Under favorable condition (chilled water temperature = FreeCTChw), the central plant can output the signal that free cooling is available (FreeCAvI) via grouping to the rooms. The rooms take the offer and go to comfort condition to use free energy for cooling with comfort setpoints. Free cooling demand is returned via the enumerated chilled water demand signal.

**Cooled water  
Deactivate sequences**

The central function can disable the chilled water equipment in the rooms based on outside temperature. The cooling sequences in the group are locked as soon as the configured value for the outside temperature is reached. Back and forth switching can be prevented using a time constant and hysteresis.

Description	Name	Default value
Cooling limit	CLm	14 [°C]
Time constant for cooling limit	TiConCLm	2 [h]
Hysteresis for cooling limit	HysCLm	1 [K]

**Condensation  
prevention**

Condensation in rooms can be prevented by shifting the chilled water temperature setpoint. Grouping records all active condensation monitors. The resulting adjustment is based on the percentage of active condensation alarms.

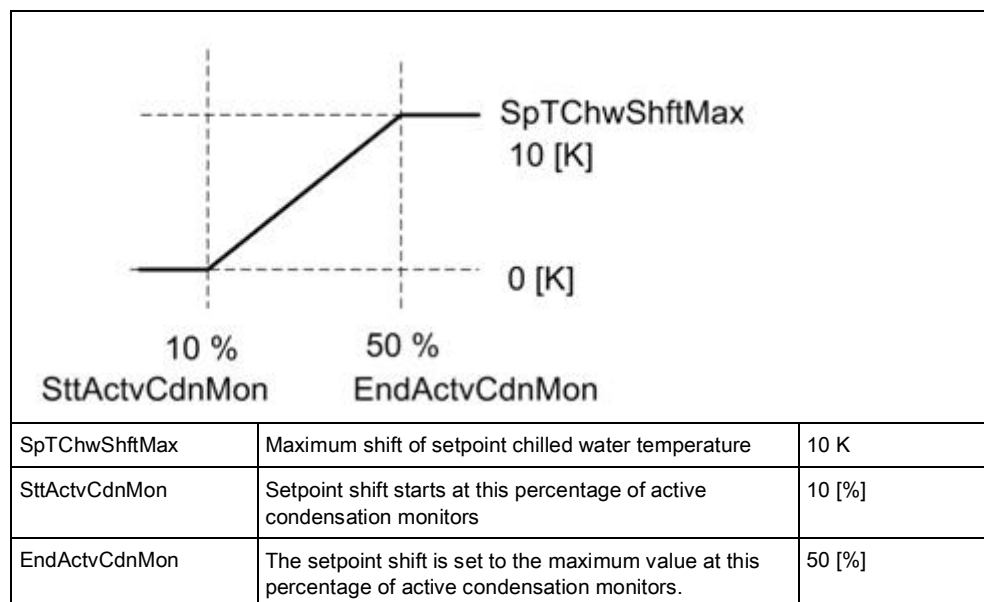

**Figure: Condensation prevention characteristic curve**

**Valve protection**

The valve actuator is operated from time to time to prevent it from blocking after longer periods of inactivity (cooling in the winter). The valve actuator is controlled to lose as little heating energy as possible.

The central function for chilled water supply chain runs the valve kick function; the configuration can be adapted as needed.

Description	Name	Default value
Kick value	KickVal	50 [%]
Kick time	TiKick	2 [Min]
Kick cycle	KickCyc	500 [h]



**Centrally override valves**

Central functions permit the central override of all valve in the supply group. The following parameters can be used.

Description	Name	Default value
Enable valve position overridden value	EnVlvPosOvrr	0:No 1:Yes
Enable valve position overridden value	VlvPosOvrr	100 [%]

**21.1.4 HVAC supply chain hot water over BACnet**

The following list includes all data points that can be read and written from a BACnet primary plant. The items ensure coordination between primary plant and the room. In addition, appropriate Desigo primary application for the given room function is mentioned.

Data point name	Description	Desigo primary application
HReq	The central function prepares one hot water demand acquisition and evaluation to the connected rooms for the primary plant. The enumerate result can include: 1:Off 2:Heating demand 3:Warm-up	PXC {HGrp65}
SpHReq	Setpoint for heating request	PXC {HGrp65}
HwTOa	BACnet reference for primary plant: Outside temperature of the hot water supply chain	Data point outside temperature of hot water supply chain

**Setpoint for heating request**

Setpoint for heating request influenced by:

- Base setpoint for heating
- Valve position(s) of heating valve in the group

**Heating curve based on outside air**

Each DXR2 automation station calculates heating and cooling demand and makes the results available via a group of the central function to the hot water supply chain.

The hot water demand setpoint is calculated in the central function using a heating curve based on the outside temperature.

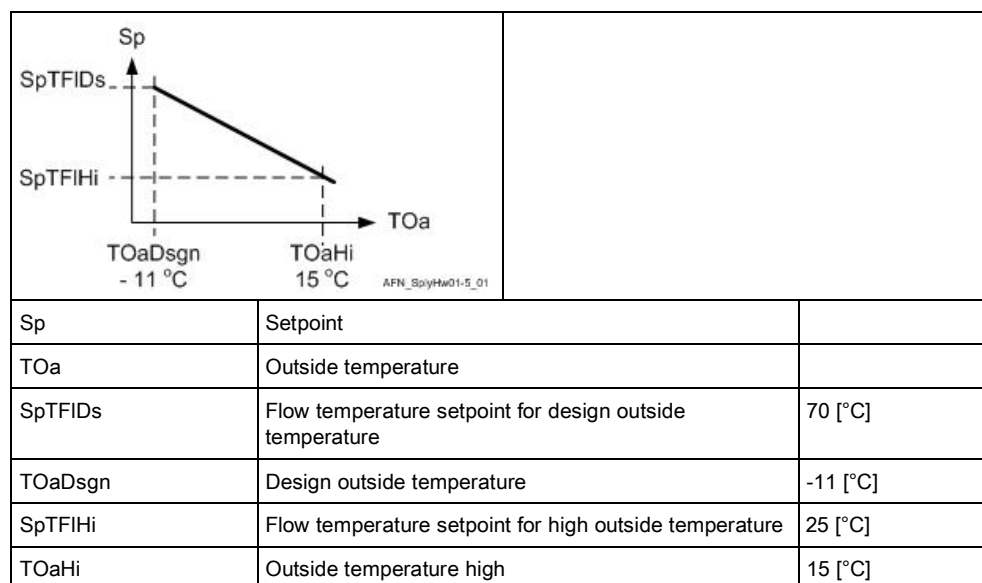

**Figure: Characteristic curve for the outside temperature-dependent heating curve**  
The cooling request setpoint is influenced by the evaluation of valve positions.

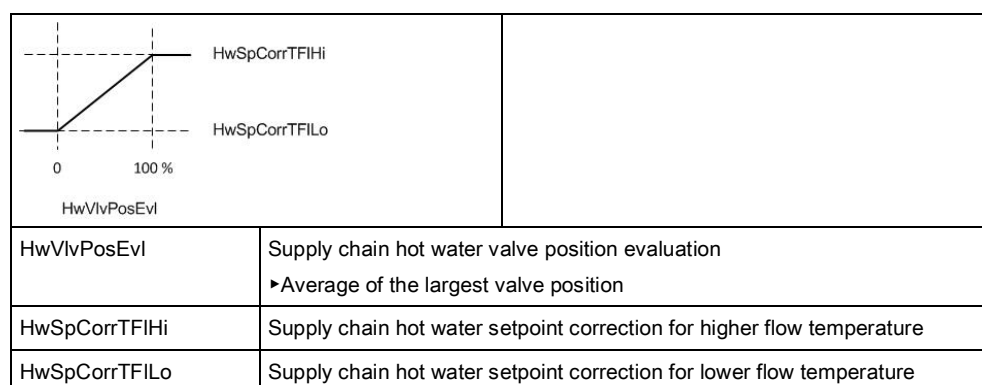

**Figure: Setpoint heating request**

### Hot water Deactivate sequences

The central function can disable the hot water equipment in the rooms based on outside temperature. The heating sequences in the group are locked as soon as the configured value for the outside temperature is reached.

Description	Name	Default value
Heating limit	HLm	16 [°C]
Time constant for heating limit	TiConHLm	2 [h]
Hysteresis for heating limit	HysHLm	1 [K]

### Valve protection

Valve actuators are operated from time to time to prevent them from seizing after long periods of inactivity (e.g. heating valve during the summer). The valve actuator is controlled to lose as little heating energy as possible.

The central function for the hot water supply chain performs the valve protection function and can be changed in the parameters as needed.

Description	Name	Default value
Kick value	KickVal	50 [%]
Kick time	TiKick	2 [Min]
Kick cycle	KickCyc	500 [h]

### Centrally override valves

Central functions permit the central override of all valve in the supply group. The following parameters can be used.

Description	Name	Default value
Enable valve position overridden value	EnVlvPosOvrr	0:No 1:Yes
Enable valve position overridden value	VlvPosOvrr	100 [%]

## 21.1.5 HVAC supply chain air over BACnet

The following list includes all data points that can be read and written from a BACnet primary plant. The items ensure coordination between primary plant and the room. In addition, appropriate Desigo primary application for the given room function is mentioned.

Data point name	Description	Desigo primary application
AhuDmd	The evaluated demand signal of the rooms to central air handling 1:Off 2:Protection 3:Economy 4:Pre-Comfort 5:Comfort 6:Warm-up 7:Cool down 8:Room low temperature protection 9:Condensation overflow protection 10:Free cooling 11:Night cooling 12:Ventilation 13:Equipment temperature protection 14:Air volume flow off 15:Smoke control positive pressure 16:Smoke control negative pressure 17:Purge	PXC {AHU80}
NumAirDmd	Number of rooms with demand	None
AQualDmd	The evaluated air quality signal of the rooms to central air handling	PXC {AHU80}
SpHiTSu	Setpoint high for supply air temperature	PXC {AHU80}
SpLoTSu	Setpoint low for supply air temperature	PXC {AHU80}

**Enable supply air supply**

On the DXR2, a threshold can be defined for the minimum number of collected air demand messages from the rooms. The air demand to air supply is only enabled if the minimum number of air demand messages is reached. The threshold and hysteresis can be configured.

Description	Name	Default value
Number of minimum air demand plant mode	AirDmdMin	4
Hysteresis for number of minimum air demand plant mode	HysAirDmdMin	2

**Select supply air temperature setpoints**

Central air handling is designed for heating and cooling. The consumers in the rooms decided whether warm or cool air is to be supplied.

Heat and refrigeration demand is determined from the rooms, evaluated, and decided, depending on the number, whether heating or cooling must be transmitted to air handling. This occurs using a lower (heating) and upper (cooling) supply air temperature setpoint to which the central air handling unit is controlled. As illustrate in the following graph, demand (0...100 %) is determined via the grouping functions for higher supply-air temperature for heating and demand (0...100 %) for lower supply air temperature for cooling. The control setpoints for supply air temperature control in the air handling unit is derived from this.

The changeover condition air reports whether the supply air can be used from the air handling unit for heating or cooling to the individual rooms. The following operating modes are supported:

- Changeover condition (ChovrCndAir) = Heating.
- Changeover condition (ChovrCndAir) = Cooling.
- Changeover condition (ChovrCndAir) = Neither.
- Changeover condition (ChovrCndAir) = Neutral.

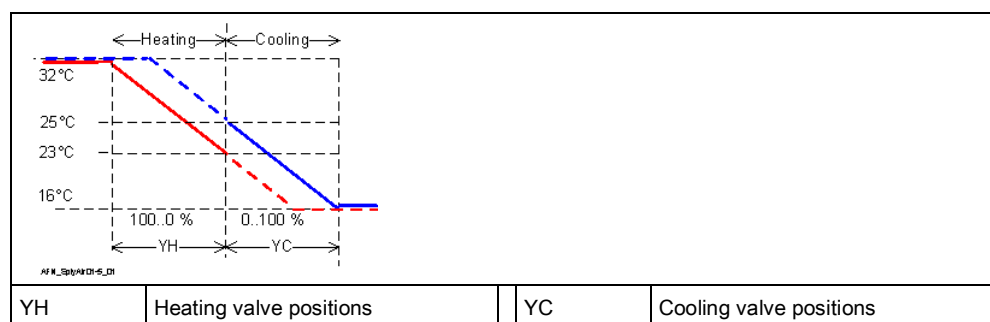
**Changeover condition heating**

The supply air setpoint for heating resides, as depicted in the diagram, on the left side, and is determined dependent on demand 0...100% accordingly. Conclusion for the room: The air is warm so that the air volume can be increased for heating.

**Changeover condition cooling**

The supply air setpoint resides, as depicted in the diagram, on the right side, and is determined dependent on demand 0...100% accordingly. Derived for the room: The air is cold so that the air volume can be increased for cooling.

**Neither changeover condition**

Heating and cooling in the VAV application is blocked and the setpoints are set to a start setpoint for heating and cooling.

- High setpoint for supply air temperature (SpHiTSu) = Start value for cooling SttValC
- Low setpoint for supply air temperature (SpLoTSu) = Start value heating SttValH

Conclusion for the room: Neither heating nor cooling, the volume flow controller for room temperature is not enabled.

**Changeover condition neutral**

Heating and cooling in the VAV application is enabled and the setpoints are set to a start setpoint for heating and cooling.

- High setpoint for supply air temperature (SpHiTSu) = Start value for cooling SttValC
- Low setpoint for supply air temperature (SpLoTSu) = Start value heating SttValH

**VAV evaluation for AirOptiControl**

The following variants are available on the DXR2 to optimize fan speed on air handling units with speed-controlled fans:

- Speed optimization via damper positions.  
The 10 largest supply air and extract air damper positions are acquired and the average calculated. The resulting value is used for fan speed optimization of the AHU.
- Speed optimization via air volume deviation.  
The deviation signals from the supply air VAV controllers are acquired from the room segments. The air volume flow deviation is calculated as:

$$((\text{air flow setpoint} - \text{measured air flow}) / \text{nominal air flow}) \times 100[\%]$$

The 10 largest deviations are evaluated and the average is used to optimize the fan stage.

The number of deviations is counted between 5...20% for monitoring.

- Speed optimization via setpoint evaluation of volume flow. It is used if supply air damper positions and measured air flows are not known. The setpoints of the supply air and extract VAV boxes is added up and the AHU fan stage is used as of this value for optimized air flow.

**Relief function**

Relief function monitoring becomes active as soon as air supply is activated. It calculates air demand for the AHU to ensure sufficient control stability of static pressure in the AHU. A relief command is outputted to the VAV controller in the group if room demand is too low; it reacts by increasing the air flow setpoint to increase air demand.

Description	Name	Default value
Configurable min. number of air demand requests required for operational stability of the central AHU. 1...50	AirDmdMax	10
Hysteresis for number of maximum air demand plant mode 1...5	HysAirDmdMax	2

Can configure whether the relief function can be activated in each room with supply VAV for each VAV:

Description	Name	Default value
Enable relief 0:No 1:Yes	EnRlf	0:No
Air volume flow relief	AirFIRlf	50 [m <sup>3</sup> /h]

### Central override of VAV

Central functions can centrally override all VAV in a supply group. The following parameters can be used.

Description	Name	Default value
Enable supply air VAV overridden value 0:No 1:Yes	EnVavSuOvrr	0:No
Supply air VAV overridden value	VavSuOvrr	50 [m <sup>3</sup> /h]
Enable extract air VAV overridden value 0:No 1:Yes	EnVavExOvrr	0:No
Extract air VAV overridden value	VavExOvrr	50 [m <sup>3</sup> /h]

## 21.1.6 Room operating mode over BACnet

The room operating mode can handed over for distribution to the room using a BACnet reference in the central function. 5 groups are available for central functions in one DXR2 for distribution of the room operating mode.

Data point name	Description	Desigo primary application
CenOpModCmdv	Central operating mode command value 1:Protection 2:Economy 3:Pre-Comfort 4:Comfort	PXC {OpMSched3}

### Delay function on large facades

Each of the four command groups for the room operating mode can be distributed in the building with a delay using three additional groups. It is used primarily in buildings with larger facades if control influences act on facades for a change to the room operating mode. The delay can be configured.

Description	Name	Default value
Central operating mode delay 1 0...7200 [s]	CenOpModDly1	10 [s]
Central operating mode delay 2 0...7200 [s]	CenOpModDly2	20 [s]
Central operating mode delay 3 0...7200 [s]	CenOpModDly3	30 [s]

## 21.2 Automation station for emergency controls for HVAC, light, and blinds

The DXR2 for emergency control, receives emergency signals (e.g. fire or evacuation) via digital inputs and takes over control of the electrical and mechanical installations for light, facade, and HVAC in a the building as long as the various supply and room automation components remain undamaged.

**CAUTION!**

It is the Danger management system, and not Desigo room automation, that is responsible for fire detection and evaluation of the correct HVAC emergency operating modes for a fire section and primary plants.

	<p><b>▲ WARNING</b></p>
	<p><b>Desigo TRA is not approved by fire authorities. Fire can result in death or serious injury.</b></p> <p>As a consequence, TRA fire solutions are only used on non-critical applications with a limited risk to health and risks,</p> <p>For critical application, an individual permit by the fire authorities on site must be acquired for a specific project.</p>

**CAUTION!**

The configurable Desigo room automation can switch all available luminaires to a specified value at the highest priority during an emergency. This is not emergency lighting or evacuation route control, but rather is only a supporting measure during an emergency to supply all rooms with the maximum brightness.

	<p><b>NOTICE</b></p>
	<p><b>The configurable Desigo room automation does not support emergency lighting control with service and test functions for decentralized or centralized batteries.</b></p>

The function is part of application types for central functions and can be loaded to a DXR2.E/M18.

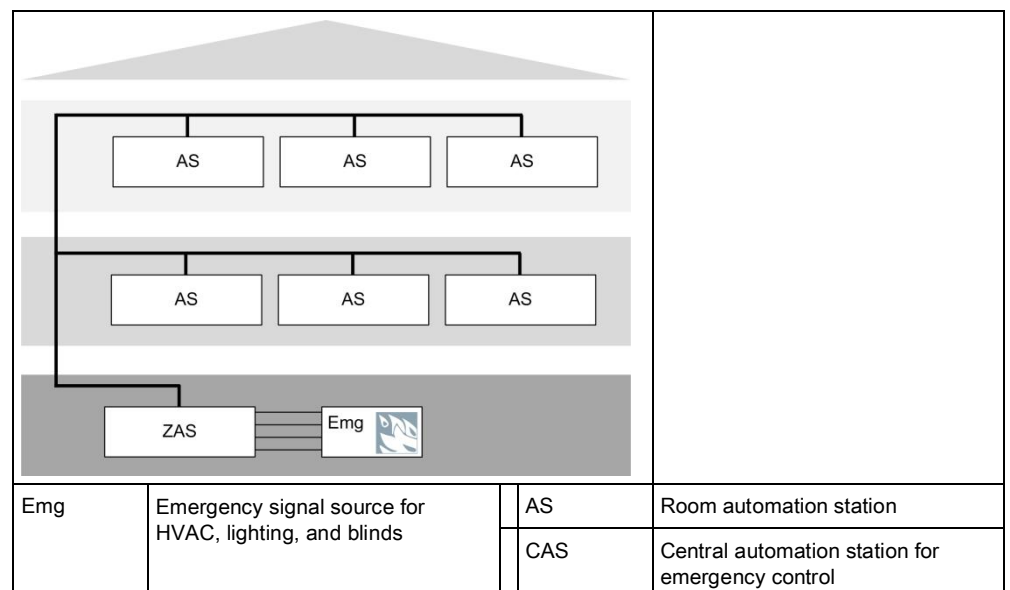

**Figure: Plant diagram for emergency control automation station**

The following input signals can be read on DXR2 for emergency controls.

Command	Inputs	Information is used for
Facade emergency control	Digital (open contact)	Application: Central emergency functions shading products drives all facade products to a configurable position at the highest priority
Light emergency control	Digital (open contact)	Application: Central emergency function lighting switches all luminaires in the building at the highest priority
HVAC emergency shutdown	Digital (open contact)	Application: Central HVAC emergency mode switches off air supply
HVAC negative pressure (extract air)	Digital (No contact)	Application: Central smoke extraction extract air
HVAC positive pressure (supply air)	Digital (No contact)	Application: Central smoke extraction supply air

**Facade emergency control** During an emergency, all facades can be deployed to a configurable position via an digital input. The command is executed at the highest priority and cannot be locally overridden in the room or from another central operation.

The facade or individual parts thereof can only be manually or automatically operating after resetting his digital command.

The emergency position of the facade can be configured.

Description	Name	Default value
Central emergency shading products command value: 1:Open 2:Height 25%, angle undef 3:Height 50%, angle undef 4:Height 75%, angle undef 5:Height 100%, angle 0% 6:Height 100%, angle 25% 7:Height 100%, angle 50% 8:Closed 9:Undefined	CenEmgShdCmdv	1:Open

The application repeats the command cyclically at the highest priority as long as the digital command for facade emergency control is active. The cycle can be configured.

Description	Name	Default value
Cycle 0...60 [min]	Cycle	15 [min]

The command for facade emergency control can be delayed with three additional groups to control larger buildings or facades.

The delay can be configured for each of the three additional groups.



Description	Name	Default value
Central emergency shading products delay 1 0...7200 [s]	CenEmgShdDly1	10 [s]
Central emergency shading products delay 2 0...7200 [s]	CenEmgShdDly2	20 [s]
Central emergency shading products delay 3 0...7200 [s]	CenEmgShdDly3	30 [s]

### Light emergency control

All luminaires can be controlled during an emergency via a digital command. The command is executed at the highest priority and cannot be locally overridden in the room or from another central operation.

Lighting can only be manually or automatically operated after this digital command is reset.

The emergency lighting control can be configured.

Description	Name	Default value
Emergency lighting level 1:Off 2:12.5% 3:25% 4:37.5% 5:50% 6:62.5% 7:75% 8:On 9:Undefined	EmgLgtLvl	8:On

The application repeats the command cyclically at the highest priority as long as the digital command for facade emergency control is active. The cycle can be configured.

Description	Name	Default value
Cycle 0...60 [min]	Cycle	15 [min]

### HVAC emergency shutdown

During an emergency, air HVAC devices in the room can be controlled via a digital command. The command is executed at the highest priority and cannot be locally overridden in the room or from another central operation.

HVAC plants can only be manually or automatically operated after this digital command is reset.

All HVAC devices in the rooms are switched off if the digital command for HVAC emergency shutdown is activated.

The function offers a test parameters that supports tests emergency reactions regardless of digital input conditions on the fixed wired interface.

Description	Name	Default value
HVAC emergency test 1:None 2:Air volume flow off 3:Smoke control positive pressure 4:Smoke control negative pressure 5:Purge	TstHvacEmg	1:None

**HVAC negative pressure**

In addition to HVAC emergency shutdown, all extract air VAV in the rooms can be used to extract smoke with negative pressure via another digital command. The command is executed at the highest priority and cannot be locally overridden in the room or from another central operation.

HVAC devices can only be manually or automatically operated after this digital command is reset.

All extract air VAV is controlled in the room to a configured air flow if the digital command is activated for this type of HVAC smoke extraction. The value can be configured separately for all extract VAV in the room:

Description	Name	Default value
Extract air VAV smoke control air volume flow setpoint	VavExSpAflSmk	50 [m <sup>3</sup> /h] 29.4 [ft <sup>3</sup> /min] 13.89 [l/s]

The function offers a test parameters that supports tests emergency reactions regardless of digital input conditions on the fixed wired interface.

Description	Name	Default value
HVAC emergency test 1:None 2:Air volume flow off 3:Smoke control positive pressure 4:Smoke control negative pressure 5:Purge	TstHvacEmg	1:None

**NOTICE****This is not a safety function for extracting smoke from buildings**

The function can only be used as a supplement to use the air supply system in support of extracting smoke in the rooms with VAV extract air as long as the associated components are still operational.

**HVAC positive pressure**

In addition to HVAC emergency shutdown, all supply air VAV in the rooms can be used to extract smoke with positive pressure via another digital command. The command is executed at the highest priority and cannot be locally overridden in the room or from another central operation.

HVAC devices can only be manually or automatically operated after this digital command is reset.

All supply air VAV is controlled in the room to a configured air flow if the digital command is activated for this type of HVAC smoke extraction. The value can be configured separately for all supply air VAV in the room:

Description	Name	Default value
Supply air VAV smoke control air volume flow setpoint	VavSuSpAflSmk	50 [m <sup>3</sup> /h] 29.4 [ft <sup>3</sup> /min] 13.89 [l/s]

The function offers a test parameters that supports tests emergency reactions regardless of digital input conditions on the fixed wired interface.

Description	Name	Default value
HVAC emergency test 1:None 2:Air volume flow off 3:Smoke control positive pressure 4:Smoke control negative pressure 5:Purge	TstHvacEmg	1:None

<b>!</b>	<p><b>NOTICE</b></p> <p><b>This is not a safety function for extracting smoke from buildings</b> The function can only be used as a supplement to use the air supply system in support of extracting smoke in the rooms with VAV extract air as long as the associated components are still operational.</p>
----------	--

### HVAC purge

All supply air and extract VAV in the rooms can be used to purge room air if both digital commands are activated together for HVAC positive and negative pressure. The command is executed at the highest priority and cannot be locally overridden in the room or from another central operation.

HVAC devices can only be manually or automatically operated after this digital command is reset.

All supply air VAV and extract VAV are controlled in the room to a configured air flow if the digital commands are activated for this type of HVAC purge. The value can be configured separately for all supply air and extract air VAV in the room.

### HVAC emergency matrix

HVAC emergency shutdown	HVAC negative pressure	HVAC positive pressure	Resulting HVAC emergency function
On	Off	Off	Emergency shutdown of all rooms connected to the group with VAV plants
On	On	Off	Negative pressure in all rooms connected to the group with VAV plants
On	Off	On	Positive pressure in all rooms connected to the group with VAV plants
On	On	On	Purge in all rooms connected to the group with VAV plants

## 21.3 Automation station for weather station

The DXR2 for central weather station can process measured values for outside temperature, precipitation, wind, and relative air humidity and provides the weather information to the widest range of applications or room operator units.

The function is part of application types for central functions and can be loaded to a DXR2.E/M18.

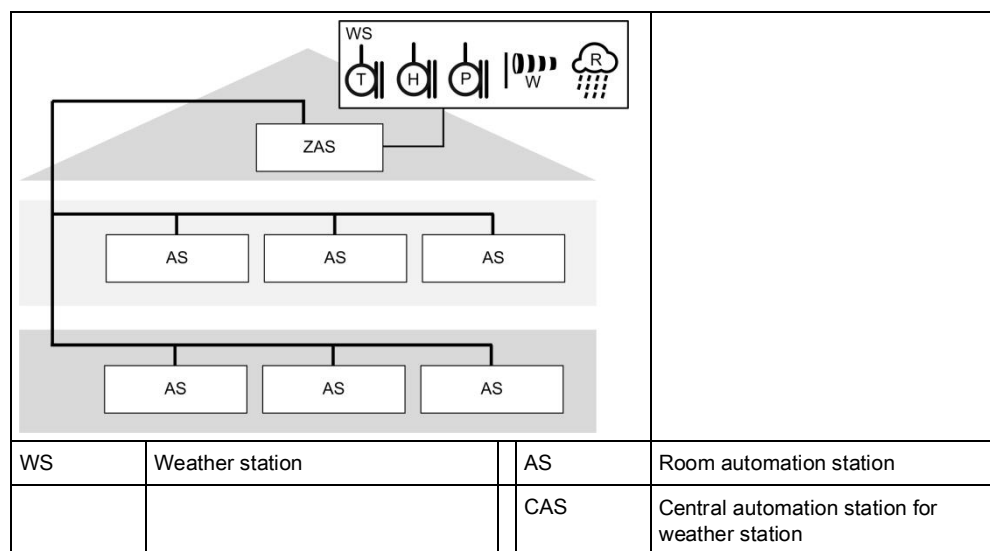

**Figure: Plant diagram for weather station automation station**

The following weather information can be read on DXR2 for weather stations:

Sensor	Inputs	Information is used for
Outside air temperature	LG-Ni1000 0... 10 V NTC100k NTC10k T1 (PTC) Pt1000	Application: Seasonal compensation Display on the room operator unit
Precipitation	Binary input (NO contact)	Application: Precipitation protection for awnings Application: Frost protection for blinds
Wind	0... 10 V	Application: Wind protection for facade products
Relative humidity	0... 10 V	Display on the room operator unit

**Seasonal compensation**

The seasonal compensation application adjusts the room temperature setpoints for Comfort heating and Comfort cooling based on outside temperature.

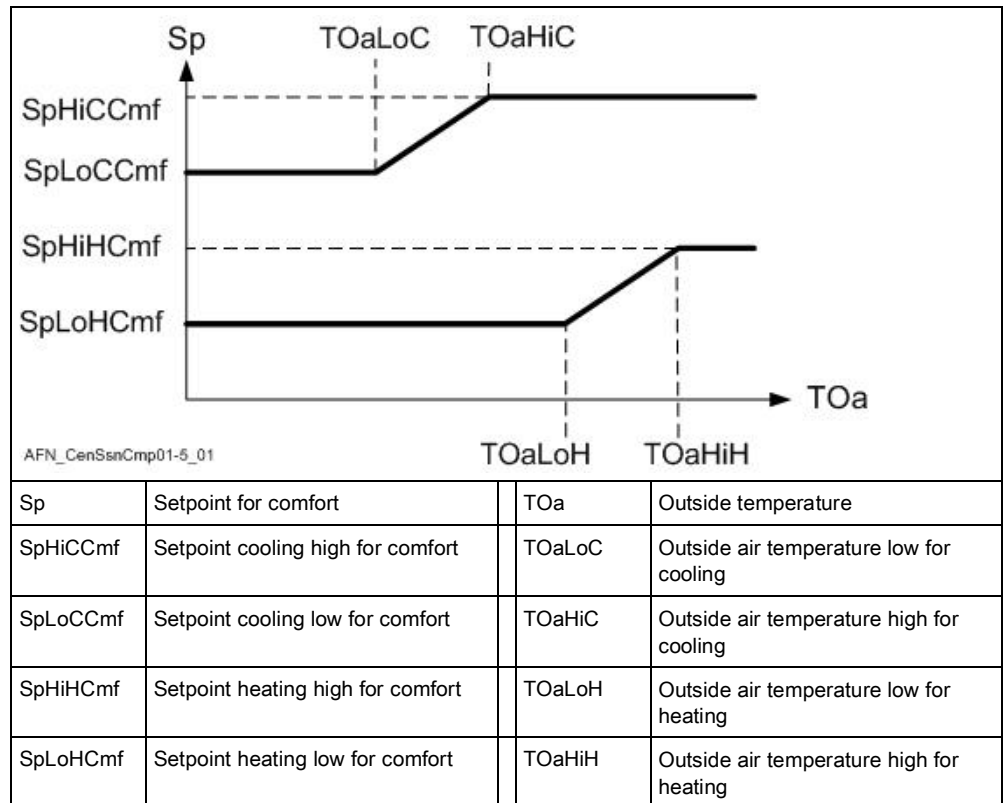

**Figure: Seasonal compensation**

Description	Name	Default value
Setpoint cooling high for comfort	SpHiCCmf	26 [°C]
Setpoint cooling low for comfort	SpLoCCmf	24 [°C]
Outside air temperature high for cooling	TOaHiC	32 [°C]
Outside air temperature low for cooling	TOaLoC	26 [°C]
Setpoint heating high for comfort	SpHiHCmf	23 [°C]
Setpoint heating low for comfort	SpLoHCmf	22 [°C]
Outside air temperature high for heating	TOaHiH	31 [°C]
Outside air temperature low for heating	TOaLoH	25 [°C]

**Wind protection for all facade products**

The application function reads the values from the wind sensor and smoothes the value using switch on and off delays. The resulting value is then compared to the configured limit values. In the event a limit value is breached, the blinds products are deployed to a configured position. A position can also be configured for a sensor fault as well.

**CAUTION!**

The permissible limit value for switch on and switch off point must be configured as per the design value of the installed shading products.

Description	Name	Default value
Switch-on point	SwiOnPt	7 [m/s]
Switch-off point	SwiOffPt	5 [m/s]
Switch-on delay protection function 0...300 [min]	DlyOnPrt	0 [min]
Switch-off delay protection function 0...300 [min]	DlyOffPrt	20 [min]
Command on limit exceed 1:None 2:Open 3:Height 25%, angle undef 4:Height 50%, angle undef 5:Height 75%, angle undef 6:Height 100%, angle 0% 7:Height 100%, angle 25% 8:Height 100%, angle 50% 9:Closed	CmdLmExc	2:Open
Command on sensor fault 1:None 2:Open 3:Height 25%, angle undef 4:Height 50%, angle undef 5:Height 75%, angle undef 6:Height 100%, angle 0% 7:Height 100%, angle 25% 8:Height 100%, angle 50% 9:Closed	CmdSenFlt	2:Open

**Frost protection for blinds**

The function is used to protect blinds or other facade products from mechanical damage caused by icing. The application function reads the values of the outside temperature sensor and precipitation detector. Frost protection is activated if the outside temperature drops below a set limit and precipitation is reported.

In the event of a frost warning, the blinds products are deployed to a configured position. A position can also be configured for a sensor fault as well.

Frost protection is automatically reset if no precipitation is reported during a configured period and the outside air temperature is above the limit value during a configurable period.

Description	Name	Default value
Switch-on point ►Limit value to trigger frost protection, only when precipitation is present.	SwiOnPt	3 [°C]
Switch-off point 1 ►Reset temperature 1, only if there is no precipitation.	SwiOffPt1	7 [°C]
Switch-off point 2 ►Reset temperature 2, only if there is precipitation.	SwiOffPt2	10 [°C]
Switch-on delay protection function	DlyOnPrt	100 [s]
Switch-off delay protection function ►Frost protection delay, if no precipitation exists and the reset temperature 1 is exceeded.	DlyOffPrt	10 [h]
Switch-off delay reset ►Switch-off delay for frost protection if reset temperature 2 is exceeded.	DlyOffRst	10 [h]
Command on limit exceed 1:None 2:Open 3:Height 25%, angle undef 4:Height 50%, angle undef 5:Height 75%, angle undef 6:Height 100%, angle 0% 7:Height 100%, angle 25% 8:Height 100%, angle 50% 9:Closed	CmdLmExc	2:Open
Command on sensor fault (Frost protection monitor) <b>Note:</b> Sensor fault precipitation must be configured at CenPcpPrt11. 1:None 2:Open 3:Height 25%, angle undef 4:Height 50%, angle undef 5:Height 75%, angle undef 6:Height 100%, angle 0% 7:Height 100%, angle 25% 8:Height 100%, angle 50% 9:Closed	CmdSenFit	1:None

**Precipitation protection function for awnings**

Use the function to protect awnings and other facade products against moisture. The application function reads the values from the precipitation detector and smoothes the value using switch on and off delays. The precipitation warning resets automatically after the switch-off delay expires. In the event of a precipitation warning, the awnings are deployed to a configured position. A position can also be configured for a sensor fault as well.

Description	Name	Default value
Switch-on delay protection function 0...18000 [s]	DlyOnPrt	100 [s]
Switch-off delay protection function 0...50 [h]	DlyOffPrt	3 [h]
Command on limit exceed 1:None 2:Open 3:Height 25%, angle undef 4:Height 50%, angle undef 5:Height 75%, angle undef 6:Height 100%, angle 0% 7:Height 100%, angle 25% 8:Height 100%, angle 50% 9:Closed	CmdLmExc	1:None
Command on sensor fault 1:None 2:Open 3:Height 25%, angle undef 4:Height 50%, angle undef 5:Height 75%, angle undef 6:Height 100%, angle 0% 7:Height 100%, angle 25% 8:Height 100%, angle 50% 9:Closed	CmdSenFlt	1:None

**CAUTION!**

The factory settings for DXR2 facade protection are designed for blinds products with active frost protection (temperature & precipitation). As a result, the factory setting for the precipitation function is switched off and switched on for frost protection. The configuration must be changed as follows when using awnings:

Frost protection function.	Command on limit exceed	CmdLmExc	1:None
Precipitation protection	Command on limit exceed	CmdLmExc	2:Open



## 21.4 Automation station for facade control

Central facade control is used to protect room users in a building against glare. The function also include thermal protection for the rooms. The measured global radiation is analyzed together with the present HVAC values in the room to prevent the room from overheating with the help of facade products.

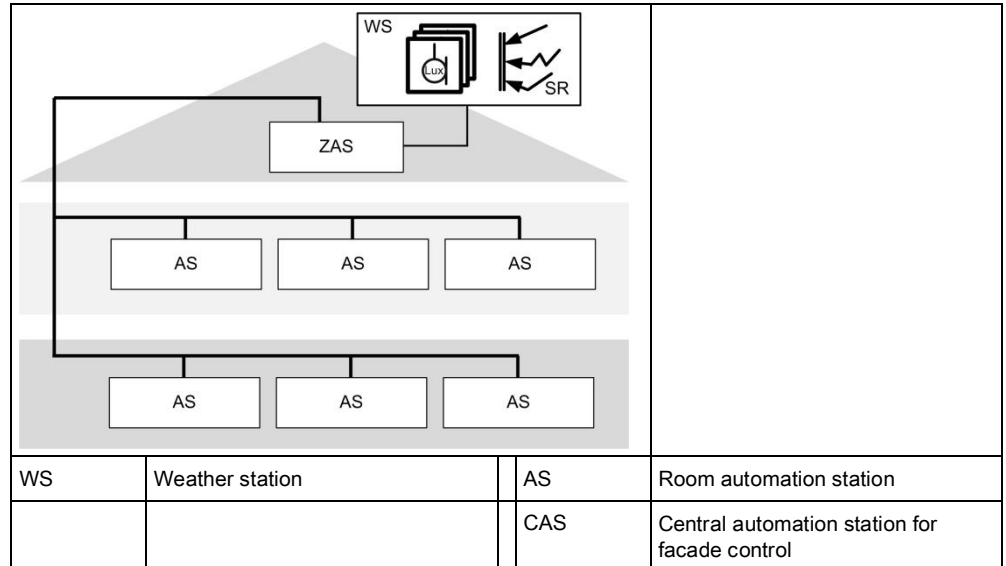

Figure: Plant diagram for fassade control automation station

### Anti-glare protection and solar position tracking

The present solar angle can be calculated based on a building's geographical position as well as date and time and use a solar sensor to evaluate solar radiation. On facade segments (i.e. windows with the same conditions with regard to anti-glare, thermal solar radiation, and brightness), this information can be used to deploy blinds or lighting control to a defined position to prevent any direct solar radiation from penetrating the room.

### Calculation of the solar angle as per the position of the building

The position data for the facade are required to determine the solar radiation angle on the facade. This permits deployment of blinds to the optimum position for anti-glare protection. Each facade possesses the following parameters for determining the position.

Description	Name	Default value
North latitude - 90 ... 90	Latit	47.17
East longitude - 180 ... 180	Lngit	8.52
Facade azimuth angle - 360 ... 360	FcdAzimuth	180 (south)
Facade angle of inclination - 90 ... 90	FcdIncl	90 (vertical)

**Measurement of solar radiation**

Solar radiation is determined using a brightness sensor. The following brightness sensors can be read on DXR2 for anti-glare protection:

Sensor	Inputs	Information is used for
Outdoor brightness north	0... 10 V	Application: Anti-glare protection
Outdoor brightness east	0... 10 V	Application: Anti-glare protection
Outdoor brightness south	0... 10 V	Application: Anti-glare protection
Outdoor brightness west	0... 10 V	Application: Anti-glare protection

**CAUTION!**

Measurements for anti-glare protection are typically made in three cardinal points since most commonly available brightness sensors have a horizontal coverage of 90°. The following applies in general depending on the position of the building:

Sensor direction	General position of the building
East, south, west	North of the Equator
East, north, west	South of the Equator

A more detailed consideration of the sensor orientation is required if the project is located near the arctic circles. On common Internet search machines, a search for "sun's course" provides useful information on the simply definition of sensor orientation.

## 21.5 Application examples

These are the descriptions of HIT applications on <http://hit.sbt.siemens.com>.

Visit the Siemens Download Center [www.siemens.com/bt/download](http://www.siemens.com/bt/download) for the latest application configurations.

### 21.5.1 Central function

CEN001	Central function weather station	A6V10662238	<a href="#">en</a> <a href="#">de</a>
CEN002	Central function facade	A6V10662238	<a href="#">en</a> <a href="#">de</a>
CEN003	Central function HVAC supply, lighting and blinds operation	A6V10662238	<a href="#">en</a> <a href="#">de</a>
CEN004	Central function emergency	A6V10662238	<a href="#">en</a> <a href="#">de</a>

## 22 Technical principles, terms

### Configurable Desigo room automation system

DXR2 room automation stations are perfectly suited to exclusively automate heating, ventilation and A/C plants.

Further, the DXR2 can be extended by adding devices with KNX PL-Link and lighting and shading functions. The configurable Desigo room automation stations offer solutions with a high level of functionality and flexibility that operate plants optimized to energy use without sacrificing Comfort (energy efficiency class A per DIN EN 15232).

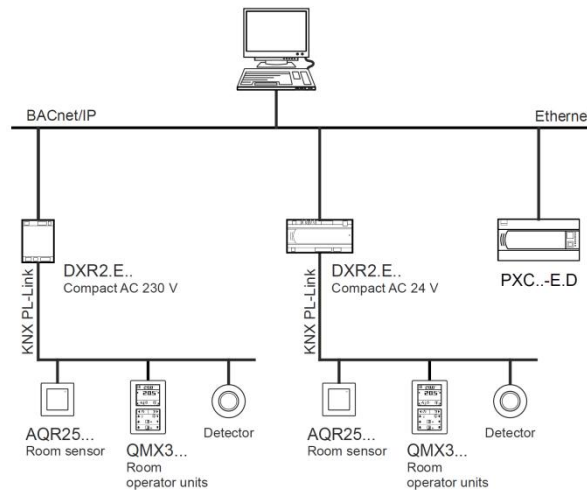

**Figure: Overview of configurable Desigo room automation system with BACnet IP**

The DXR2 room automation station can automate heating, ventilation, A/C, lighting, and shading in the room.

Depending on the model, communication among the stations or to other system components takes place over BACnet/IP (DXR2.E...) or BACnet MS/TP (DXR2.M...).

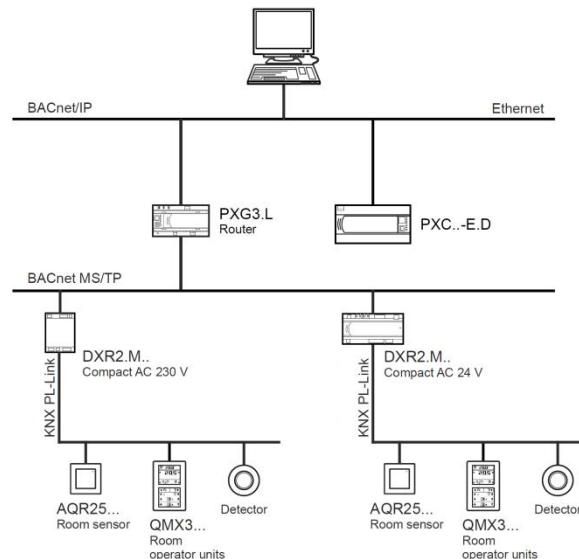

**Figure: Overview of configurable Desigo room automation system with BACnet MS/TP**

Room automation stations have a fixed number of I/O data points for connecting field devices as well as an interface to KNX. The automation stations are supplied with pre-loaded applications that only need be configured. A comprehensive library with tested, standardized applications is available that can be used instead of the pre-loaded applications. Buttons, sensors, and actuators for lighting and shading are connected to the room automation station via the KNX PL-Link.

Both preloaded as well as tested standardized applications in the library are configured in ABT Site and offer a high degree of flexibility, since, in addition to the functions, even inputs and outputs on the DXR2... can be configured.

## DXR2

DXR2 room automation stations:

- DXR2 assume the control functions for a room.
- DXR2s communicate with each other or other system components via BACnet/IP or MS/TP. Scope and functionality of supported BACnet objects are matched to the requirements of room automation.
- DXR2s provide a 2-port Ethernet interface for cost-effective cabling via line topology.
- DXR2s receive bus power for the KNX PL-Link. Internal bus power can be extended needed with an external supply module.

## KNX PL-Link

The KNX PL-Link (Peripheral Link) connects communicating room and field devices (room devices, sensors, actors) to the DXR2 room automation station. Plug&play allows for connecting selected Siemens field devices to the KNX PL-Link using plug and play.

KNX PL-Link is not suitable for KNX subsystem integration, as communication is not directly between field devices but field devices and room automation station.

The DXR2 has its own KNX PL-Link has bus-internal supply allowing for cost-effective installation without requiring additional wiring. The 2-wire bus allows for connecting up to 64 devices.

DXR2 applications include an optimum set of preconfigured devices. They support simple engineering.

KNX PL-Link provides extended functionality and additional diagnostic functions compared to direct connected field devices.

## Groups

In Desigo room automation, numerous system elements and system data are grouped by means of grouping functions.

- Groups allow structuring and central control of system elements and data.
- Groups support data exchange between central control functions and individual system elements.

System elements and data can be grouped by either geographical, functional, or discipline-specific criteria.

Typical reasons for exchanging data within a group:

- Distributing common group data by central function.
- Collecting data from individual group elements.
- Calculating resulting group data via central function.
- Merging room segments to multiple DXR2s into one large room

**Room** DXR2 can control one room. One segment also belongs to the room in each DXR2. The DXR2 includes the control function for the room as well as control function for the associated room segment.

**Room segment** Each DXR2 includes, in addition to the control for the room, control for the associated room segment. A room segment is the smallest indivisible element in the building.

**Application types** An application type includes all possible versions of an application. The application type forms the starting point for configuring a DXR2 automation station. Functions for the associated application functions are enabled or disabled by selecting or clearing the function.

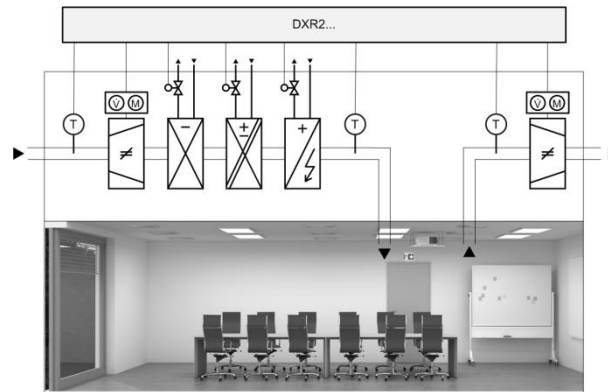
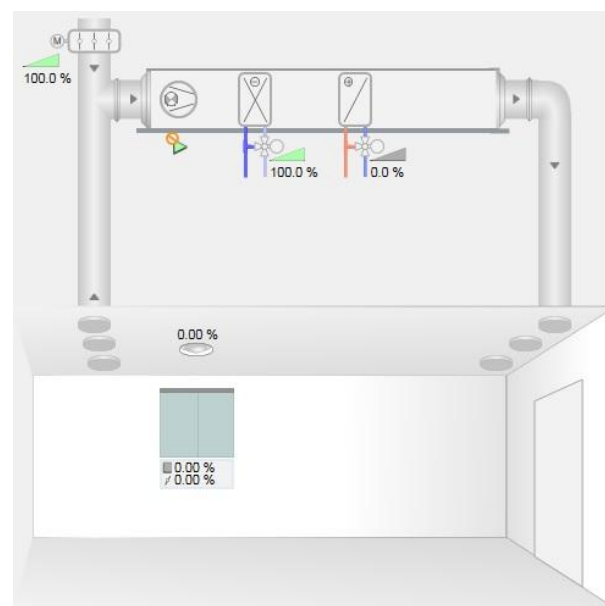

**Figure: HVAC depiction of VAV application type**

There are four application types on configurable Designo room automations:

- VAV including radiators and heated/chilled ceilings
- Fan coil including radiators and heated/chilled ceilings
- Fan powered box including radiators and heated/chilled ceilings
- Central functions

**Management station** The Designo management station graphics library supports the most important DXR2 application data points.



**Figure: Fan Coil application on the Designo CC Management Station**

## Alarms

BACnet distinguishes for alarming between Intrinsic Reporting and Algorithmic Change Reporting. Designo room automation uses Algorithmic Change Reporting.

The BACnet object is not alarm capable on its own. Alarms and events (notifications) are generated via an additional Event Enrollment object.

The event enrollment object references a value (property) for monitoring from another BACnet object, e.g. analog input, analog value, or in the form of a binary or multistate signal.

Details on monitoring are defined using the following event algorithms within the event enrollment object.

Event algorithms	Function
Wertänderung/ Change of value	Monitoring for change of value of an analog value. The change of value can be individually set.
Zustandsänderung/ Change of state	Monitoring for a definable state, such as program state, system state, load shedding state, silenced, door state, security level, binary value, etc.
Bitstringwert verändert/ Change of bitstring	Monitoring a bitstring value for a specific state such as In Alarm, or fault.
Ausser Bereich/ Out of range	Monitor Real value for a high/low limit value including delay time and neutral zone.
Fehler bei der Befehlsausführung/ Command failure	Feedback monitoring: Monitors, via two references, whether a feedback to a switching command occurs within a defined period.
Nicht feste Grenze/ Floating limit	Floating limits: Can monitor, via two references, whether the actual value is located with an adjustable range around the setpoint.

You can still define prioritization, alarming (acknowledge and reset) as well as response (alarm or event notification) on the event enrollment object (similar to intrinsic reporting). In other words, all required properties are available on the object and can be edited specific to the application during engineering as well as from a BACnet client.

**Standard BACnet object for alarms**

Standard BACnet objects are compiled from a series of properties. The functional response and state are displayed from these properties. BACnet uses the following properties:

Property	State	Description
Zustandsflagge, Status flag	In Alarm	True process alarm, e.g. high limit is exceeded or low limit breached for an analog input of value object.
	In Alarm, fault	System alarm for no sensor, short circuit, interrupt, etc.
	Out of service.	When the object is placed out of service.
	Overridden.	Local override on an I/O module.
Reliability	No error. No sensor Short circuit. No output module Over range Under the range etc.	

Issued by  
Siemens Switzerland Ltd  
Building Technologies Division  
International Headquarters  
Gubelstrasse 22  
CH-6301 Zug  
+41 41-724 24 24  
[www.siemens.com/buildingtechnologies](http://www.siemens.com/buildingtechnologies)

© Siemens Switzerland Ltd, 2016  
Technical specifications and availability subject to change without notice.